

# AquaLink® TRI® Controller

## **WARNING**

**FOR YOUR SAFETY** - This product must be installed and serviced by a licensed electrician in accordance with AS/NZ 3000 - 2007 and any other local regulations. Before installing this product, read and follow all warning notices and instructions that accompany this product. Failure to follow warning notices and instructions may result in property damage, personal injury, or death. Improper installation and/or operation will void the warranty.

Improper installation and/or operation can create unwanted electrical hazard which can cause serious injury, property damage, or death.

**EQUIPMENT INFORMATION RECORD**

DATE OF INSTALLATION \_\_\_\_\_

INSTALLER INFORMATION \_\_\_\_\_

INITIAL PRESSURE GAUGE READING (WITH CLEAN FILTER) \_\_\_\_\_

PUMP MODEL \_\_\_\_\_

HORSEPOWER \_\_\_\_\_

FILTER MODEL \_\_\_\_\_

\_\_\_\_\_

CONTROL PANEL MODEL \_\_\_\_\_

SERIAL NUMBER \_\_\_\_\_

NOTES: \_\_\_\_\_

\_\_\_\_\_

## Table of Contents

<b>Section 1. Important Safety Instructions</b> .....	<b>4</b>	<b>Section 8. Service Mode</b> .....	<b>20</b>
<b>Section 2. System Overview</b> .....	<b>6</b>	<b>Section 9. Pool/Spa System Menu</b>	
2.1 Package Contents .....	6	<b>Flow Diagrams</b> .....	<b>21</b>
2.2 Electrical Specifications.....	6	9.1 Main Menu.....	21
2.3 Materials and Tools .....	7	9.2 Install Settings Menu.....	22
<b>Section 3. Install Controller Box</b> .....	<b>7</b>	<b>Section 10. Pool Only System Menu</b>	
3.1 Mount the Controller Enclosure.....	7	<b>Flow Diagrams</b> .....	<b>23</b>
3.2 Mount the User Interface for Remote Access.....	8	10.1 Main Menu.....	23
<b>Section 4. Mains Voltage Wiring</b> .....	<b>8</b>	10.2 Install Settings Menu.....	24
4.1 Ground Fault Circuit Interrupter.....	10	<b>Section 11. Glossaries</b> .....	<b>25</b>
<b>Section 5. Extra Low Voltage Wiring</b> .....	<b>10</b>	11.1 Glossary of Safety Delays and Lockouts.....	25
5.1 Wire the Temperature Sensors.....	10	11.2 Glossary of Alert Messages.....	25
5.2 Install iAquaLink™ (if applicable).....	11		
5.3 Install Jandy Valve® Actuators (JVAs) (if applicable) ...	11		
<b>Section 6. System Setup, Programming</b>			
<b>and Testing</b> .....	<b>12</b>		
6.1 Basic Navigation.....	12		
6.2 Set the System Type .....	12		
6.3 Set the Clock.....	12		
6.4 Define Equipment ON/OFF Schedules .....	13		
6.5 Test the AquaLink TRI .....	13		
<b>Section 7. Install Settings</b> .....	<b>14</b>		
7.1 Freeze Protect.....	15		
7.2 Units .....	16		
7.3 Languages.....	16		
7.4 Clear Memory.....	16		
7.5 Pump.....	16		
7.6 Color Lights .....	17		
7.7 Label Auxiliary Functions.....	17		
7.8 Temp Calibrate .....	18		
7.9 Solar Priority (if applicable) .....	18		
7.10 Assign JVA .....	18		
7.11 Assign Hotkeys.....	19		
7.12 Ext. SWC Power.....	19		
7.13 Diagnostics.....	19		

## Section 1. Important Safety Instructions

# READ AND FOLLOW ALL INSTRUCTIONS

All electrical work must be performed by a licensed electrician and conform to all national, state, and local codes. When installing and using this electrical equipment, basic safety precautions should always be followed, including the following:

### **⚠ DANGER**

To reduce the risk of severe injury or death, do not remove the suction fittings of your spa or hot tub. Never operate a spa or hot tub if the suction fittings are broken or missing. Never replace a suction fitting with one rated less than the flow rate marked on the equipment assembly.

### **⚠ WARNING**

Prolonged immersion in hot water may induce hyperthermia. Hyperthermia occurs when the internal temperature of the body reaches a level several degrees above the normal body temperature of 37°C (98.6°F). The symptoms of hyperthermia include dizziness, fainting, drowsiness, lethargy, and an increase in the internal temperature of the body. The effects of hyperthermia include: 1) unawareness of impending danger; 2) failure to perceive heat; 3) failure to recognize the need to exit spa; 4) physical inability to exit spa; 5) fetal damage in pregnant women; 6) unconsciousness resulting in a danger of drowning.

### **⚠ WARNING**

#### **To Reduce the Risk of Injury -**

- a) The water in a spa should never exceed 40°C (104°F). Water temperatures should remain between 38°C (100°F) and 40°C (104°F). The water in a spa should never exceed 40°C (104°F). Water temperatures between 38°C (100°F) and 40°C (104°F) are considered safe for a healthy adult. Lower water temperatures are recommended for young children and when spa use exceeds 10 minutes.
- b) Since excessive water temperatures have a high potential for causing fetal damage during the early months of pregnancy, pregnant or possibly pregnant women should limit spa water temperatures to 38°C (100°F). Before entering a spa or hot tub, the user should measure the water temperature with an accurate thermometer since the tolerance of water temperature-regulating devices varies.
- d) The use of alcohol, drugs, or medication before or during spa or hot tub use may lead to unconsciousness with the possibility of drowning.
- e) Obese persons and persons with a history of heart disease, low or high blood pressure, circulatory system problems, or diabetes should consult a physician before using a spa.
- f) Persons using medication should consult a physician before using a spa or hot tub since some medication may induce drowsiness while other medication may affect heart rate, blood pressure, and circulation.

### **⚠ WARNING**

**Risk of electric shock** - Install the controller at least 3.5 metres from the inside wall of the pool and/or hot tub using non-metallic plumbing.

Children should not use spas or hot tubs without adult supervision.

Do not use spas or hot tubs unless all suction guards are installed to prevent body and hair entrapment.

People using medications and/or having an adverse medical history should consult a physician before using a spa or hot tub.

### **⚠ WARNING**

To avoid injury ensure that you use this control system to control only packaged pool/spa heaters which have built-in operating and high limit controls to limit water temperature for pool/spa applications. This device should not be relied upon as a safety limit control.

## ⚠ WARNING

People with infectious diseases should not use a spa or hot tub.

To avoid injury, exercise care when entering or exiting the spa or hot tub.

Do not use drugs or alcohol before or during the use of a spa or hot tub to avoid unconsciousness and possible drowning.

Before entering a spa or hot tub, measure the water temperature with an accurate thermometer.

Do not use a spa or hot tub immediately following strenuous exercise.

Prolonged immersion in a spa or hot tub may be injurious to your health.

Do not permit any electric appliance (such as a light, telephone, radio, or television) within 3.5 metres of a spa or hot tub.

The use of alcohol, drugs or medication can greatly increase the risk of fatal hyperthermia in hot tubs and spas.

Water temperature in excess of 38°C (100°F) may be hazardous to your health.

## ⚠ WARNING

A terminal bar marked "GROUND" is provided within the controller. To reduce the risk of electrical shock which can cause serious injury or death, connect this terminal bar to the grounding terminal of your electric service or supply panel with a continuous copper conductor having green insulation and one that is equivalent in size to the circuit conductors supplying this equipment in accordance with AS/NZ 3000 - 2007. In addition, where required, bonding should be extended in accordance with AS/NZ 3000 - 2007 to any metal ladders, water pipes, or other metal within 3.5 m of the pool/spa.

## ⚠ CAUTION

Power to the Aqualink TRI should be supplied by an isolating transformer or through a residual current device (RCD) with a rated residual operating current not exceeding 30mA.



**Attention Installer:** Install to provide drainage of compartment for electrical components.

# SAVE THESE INSTRUCTIONS

## Section 2. System Overview

### 2.1 Package Contents

Package contents will vary depending on which AquaLink TRI configuration you are installing.

AquaLink TRI PSi	AquaLink TRI PS
<ul style="list-style-type: none"> <li>• Four Function Controller with removeable User Interface (UI)</li> <li>• iAquaLink™</li> <li>• Jandy Valve® Actuators (2)</li> <li>• Water Temperature Sensor Kit</li> <li>• Mounting Hardware</li> <li>• Mounting Bracket</li> <li>• Mounting Bracket for remotely installing UI</li> <li>• Cover plate for UI housing</li> <li>• Installation Manual/ Owner's Manual</li> </ul>	<ul style="list-style-type: none"> <li>• Four Function Controller with removeable User Interface (UI)</li> <li>• Jandy Valve Actuators (2)</li> <li>• Water Temperature Sensor Kit</li> <li>• Mounting Hardware</li> <li>• Mounting bracket</li> <li>• Mounting Bracket for remotely installing UI</li> <li>• Cover plate for UI housing</li> <li>• Installation Manual/ Owner's Manual</li> </ul>
AquaLink TRI Pi	AquaLink TRI P
<ul style="list-style-type: none"> <li>• Four Function Controller with removeable User Interface (UI)</li> <li>• iAquaLink™</li> <li>• Water Temperature Sensor Kit</li> <li>• Mounting Hardware</li> <li>• Mounting bracket</li> <li>• Mounting Bracket for remotely installing UI</li> <li>• Cover plate for UI housing</li> <li>• Installation Manual/ Owner's Manual</li> </ul>	<ul style="list-style-type: none"> <li>• Four Function Controller with removeable User Interface (UI)</li> <li>• Water Temperature Sensor Kit</li> <li>• Mounting Hardware</li> <li>• Mounting bracket</li> <li>• Mounting Bracket for remotely installing UI</li> <li>• Cover plate for UI housing</li> <li>• Installation Manual/ Owner's Manual</li> </ul>

### 2.2 Electrical Specifications

<b>Power Supply</b>	<b>240 VAC; 50 Hz; 2.5 A</b>
<b>Contact Rating</b>	<b>Mains Voltage - 25 A; 3HP @ 240 VAC 1500 Watts Incandescent</b>
	<b>Extra Low Voltage - Class 2, 1 A @ 24 VAC</b>

## 2.3 Materials and Tools

### Installation Materials Furnished

- Screw Set (includes Plastic Anchors)
- Metal Mounting Bracket

### Tools Needed for Installation

- Power Drill
- 3/16" Drill Bit - Hammer Drill Bit (only necessary to drill into brick or concrete)
- Conduit Fittings
- Wire Nuts
- Wire Crimping Pliers
- Pencil or Marking Pen
- Flat Head Screwdriver
- Phillips Head Screwdriver
- Small Flathead or Slotted Screwdriver

## Section 3. Install Controller Box

### WARNING

**FOR YOUR SAFETY:** This product must be serviced by a professional pool/spa service technician as described on the front cover of this manual. The procedures in this manual must be followed exactly. Failure to follow warning notices and instructions may result in property damage, serious injury, or death. Improper installation and/or operation will void the warranty.

When mounting the controller box in the equipment pad, instructions must be followed exactly. Read through the Important Safety Information section completely before beginning installation and before operating the equipment.

Before you begin installation, make sure you have the necessary tools and a suitable location to install the AquaLink TRI.

**NOTE** The controller should be located at or near the equipment pad.

Locate the controller at least 3.5 metres or more away from pool/spa and 1.5 metres off the ground. All national, state, and local codes are applicable.

### 3.1 Mount the Controller Enclosure

1. Using a flat screwdriver, rotate door tumblers one half turn counter-clockwise to unlock the front cover of the controller.
2. Open the front cover door and remove the mounting hardware kit taped on the inside of the controller enclosure. Unpack the metal mounting bracket.
3. Using the holes in the bracket as a guide, mark four (4) dots on the surface where the controller will be mounted. The four (4) mounting holes are 10 cm (3-15/16") apart center to center. Use a level to check position before drilling to ensure accuracy.

**NOTE** Make sure to mark out the four (4) holes as accurately as possible.

4. Drill four (4) holes in the mounting surface.
5. Press the four (4) plastic anchors firmly into holes.
6. Screw the mounting bracket onto the mounting surface with the four (4) screws provided.

## ⚠ CAUTION

Make sure to perform the following step **BEFORE** mounting the enclosure onto the mounting bracket, otherwise, damage to the threaded hole of the mounting bracket may occur.

- Open the front cover of the controller and locate the fastening hole under the ground bar. Use a drill size 3/16" to drill through the plastic enclosure. This is the fastening hole aligned with the threaded hole of mounting bracket.
- Line up the slot in the controller enclosure with the guide in the mounting bracket and hook on to mount.
- Secure the controller enclosure to the mounting bracket with the single fine thread Phillips screw provided.

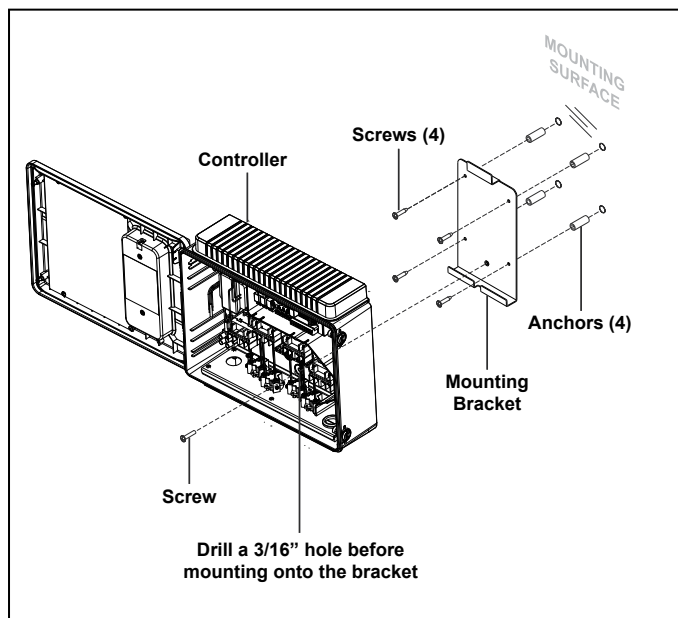

Figure 1. Mounting the Controller Enclosure

### 3.2 Mount the User Interface for Remote Access

For ease of use, you may remove the user interface (UI) from the controller enclosure and install it in a location away from the equipment pad.

**NOTE:** To set up the UI this way, use the provided 5 metre length of cable. If a longer length is required this can be purchased from most leading electronics retailers (common phone cable with RJ11 jacks should be used).

## ⚠ WARNING

When installing the UI for remote use, UI must be located where a service professional may access it and the blanking panel (provided) must be installed in place on the controller door.

- Using the holes in the metal bracket as a guide, drill two (2) holes on the surface where the UI will be mounted.
- Screw the bracket to the surface using two (2) screws.
- Remove the UI from the front of the controller enclosure and attach magnetically to the mounting plate.
- Use the plastic face plate provided to cover the UI housing when UI is removed. Attach face plate to enclosure door with two screws retained from UI removal.

## Section 4. Mains Voltage Wiring

### ⚠ WARNING

Potentially high voltages in the AquaLink TRI controller can create dangerous electrical hazards, possibly causing death, serious injury or property damage. Turn off power at the main circuit feeding the AquaLink TRI controller to disconnect the power center from the system.

### ⚠ WARNING

Zodiac Group Australia PTY LTD advises that any procedure requiring potential contact with live electrical wiring and/or parts other than cords and plugs connected to electrical outlets, be completed by a licensed electrical contractor qualified in pool equipment as described on the front of this manual. Failure to follow warning notices and instructions may result in property damage, serious injury, or death.

All mains voltage wiring must be done by a licensed electrical contractor.

**NOTE:** See *Figure 2. AquaLink TRI Electrical Wiring Diagram* for specific wire locations and connections.



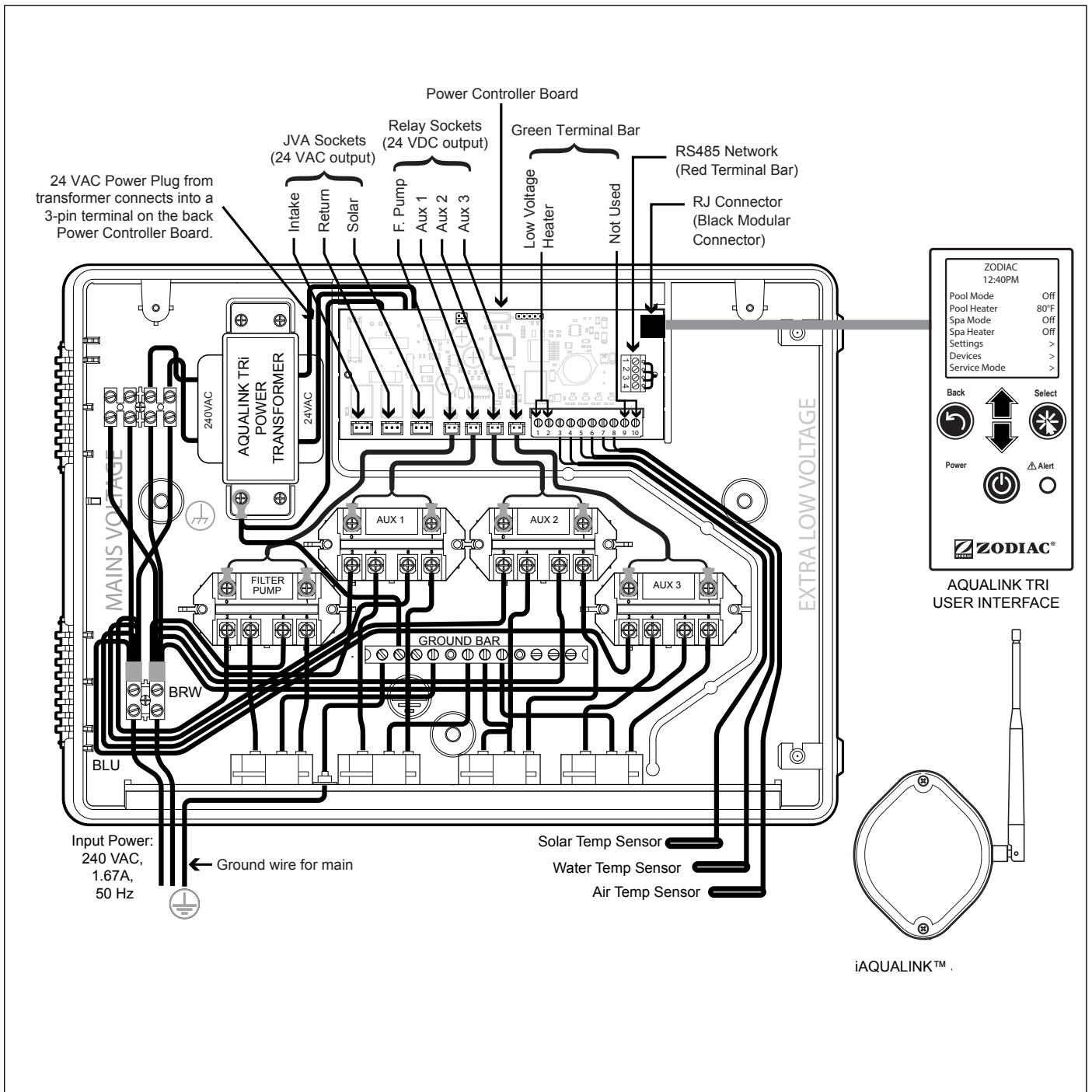

Figure 2. AquaLink TRI Controller Electrical Wiring Diagram

## 4.1 Ground Fault Circuit Interrupter

### **⚠ WARNING**

When using electrical products, basic precautions should always be followed, including the following:

- **DANGER: RISK OF ELECTRIC SHOCK WHICH CAN RESULT IN SERIOUS INJURY OR DEATH.** Before attempting installation or service, ensure that all power to the device is disconnected/turned off at the circuit breaker. Connect only to a circuit protected by a residual current device (RCD) with a rated residual operating current not exceeding 30mA.
- Grounding is required. The unit should be installed by a licensed electrician and should be properly grounded and bonded.
- Install to permit access for servicing.
- Please read all cautions and safety instructions in the Important Safety Instructions section. **Before attempting any electrical wiring, be sure to read and follow safety instructions. Wiring should only be attempted by a licensed electrician.**

## Section 5. Extra Low Voltage Wiring

All extra low voltage wiring should be run through the rubber grommet fittings in the extra low voltage compartment (right side of controller enclosure). Slice through the rubber with a box cutter knife in order to feed low voltage wires into the cabinet. See Figure 4.

### **IMPORTANT**

Never run mains voltage and extra low voltage in the same conduit.

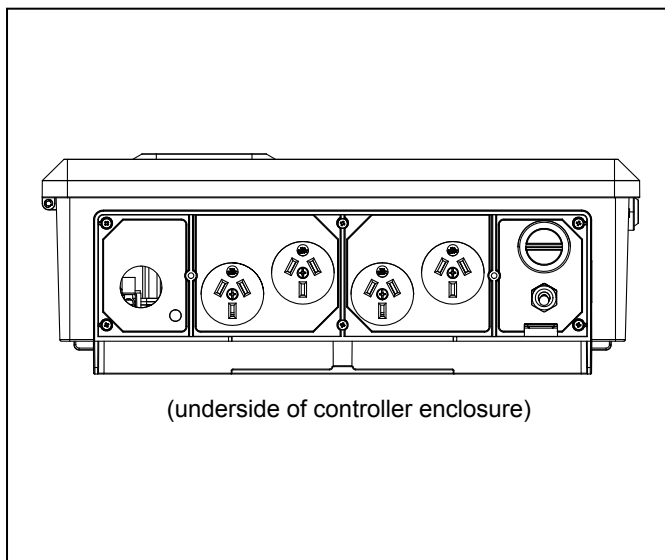

(underside of controller enclosure)

Figure 4. Grommets for extra low voltage wiring

## 5.1 Wire the Temperature Sensors

Wire the temperature sensors on the 10-pin green connector (see Figure 2. Wiring Diagram). The air temperature sensor is factory-installed on the 10-pin green connector (pins 7,8). The water temperature sensor and necessary installation hardware is included.

### 5.1.1 Install the Water Temperature Sensor

1. Drill a hole for mounting the water temperature sensor line in the pipe between the pump and the filter (before the heater).
2. Install the O-ring on the sensor and insert the sensor into the hole. Wrap and tighten metal clamp around the pipe to secure sensor.
3. Feed the sensor wire through the black extra low voltage wiring grommet.
4. Strip 5mm of insulation and separate the wires.
5. Connect sensor wires to pins 5, 6 of the 10-pin green connector.

### 5.1.2 Install a Solar Sensor (if applicable)

If there is a solar heating system in the equipment configuration, wire the solar heater temperature sensor to the 10-pin green connector. The solar sensor should be installed adjacent to the solar panel so it will sense the same temperature as the solar panels. Do not install in the pipe.

1. Feed the sensor wire through the black extra low voltage wiring grommet.
2. Strip 5mm of insulation and separate the wires.
3. Connect sensor wires to pins 3, 4.

### 5.1.3 Install Additional Extra Low Voltage Equipment (if applicable)

If there is additional extra low voltage equipment installed, such as extra low voltage heating, wire temperature sensor to pins 1, 2 on the 10-pin green connector (see Figure 2. Wiring Diagram).

## 5.2 Install iAquaLink™ (if applicable)

iAquaLink is included in PSi and Pi kits only.

**NOTE:** For complete instructions and safety information, refer to the iAquaLink Quick Start Guide (included in the iAquaLink packaging), or the full iAquaLink manual (found online at [www.zodiac.com.au](http://www.zodiac.com.au)).

### 5.2.1 Mount the iAquaLink Device

Mount the iAquaLink at least 2 metres off the ground and at least 2.5 metres from any motors, such as a blower.

1. Mark and drill two (2) holes in the selected surface.
2. Press two (2) plastic anchors firmly into holes.
3. Screw the device onto the mounting surface with the two (2) screws provided.

### 5.2.2 Wiring in RS485 Communication Devices

Compatible RS485 devices (e.g., Zodiac TRi saltwater chlorinator, Zodiac ePump variable speed filter pump, or iAquaLink) must be connected through the RS485 red pin terminal bar. For further installation instructions consult the owners manual of the specific product.

#### Connection of Zodiac TRi–

Using 4 core cable (WCABLE) wire a suitable length into the TRi Green terminal bar onto the appropriate contacts as follows,

- 1-Green wire (0V) to '0V' terminal on the TRi
- 2-Red wire to the (+V) 'POS' terminal on the TRi
- 3-Yellow/White (B) wire to 'B' terminal on TRi
- 4-Black wire (A) to 'A' terminal on TRi

Once these connections are in place, follow the wiring instructions to connect to the AquaLink TRi.

#### Connection of Zodiac ePump–

Remove the rear motor cover and ensure all 4 dip switches are in the OFF position. The ePump already has a 4 core cable fitted to the pump. However you will need to cut off the red 4 pin bar from the cable and follow the wiring instructions below to connect to the AquaLink TRi.

#### Connection of iAquaLink–

Follow the wiring instructions to connect to the AquaLink TRi.

**Wiring Instructions for connecting to AquaLink TRi–** Steps 1-3 below show connecting devices into the RS485 port in AquaLink TRi.

1. Feed wire through the black extra low voltage wiring grommet.
2. Strip 1/4" of insulation and separate the wires.
3. Connect four (4) separate wires to each terminal (Figure 5).

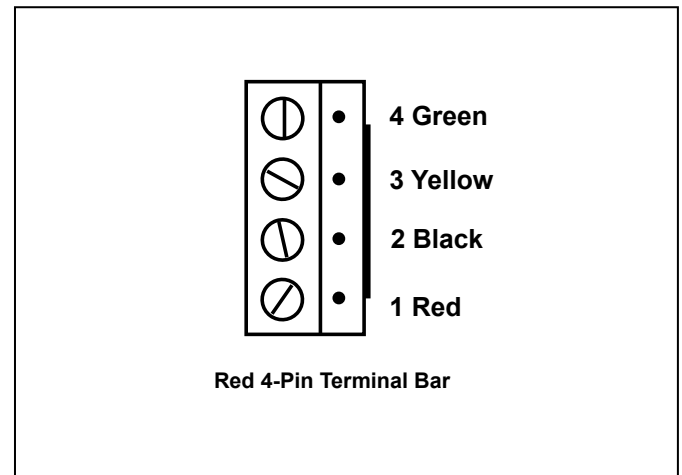

**Figure 5. RS-485 Wiring**

**NOTE:** Wire only two (2) devices (e.g. the iAquaLink™ and one additional device) to the RS-485 connector. If you have more than one additional device in your equipment configuration, use a multiplex board. This can be ordered from your Zodiac Stockist (part number W6584).

## 5.3 Install Jandy Valve® Actuators (JVAs) (if applicable)

You may wire up to three JVAs on the AquaLink TRi. Two (2) JVAs are included in PSi and PS (Pool/Spa combo) kits. An additional JVA may be required on a pool/spa combination configuration to control a water feature or solar heater, for example.

**NOTE:** Read and follow complete installation instructions and safety information in the Jandy Valve Actuator owner's manual (included in the JVA packaging).

1. Install intake JVA and return JVA on equipment lines according to installation instructions in the owner's manual.
2. Feed intake JVA wire through the black extra low voltage wiring grommet.
3. Plug JVAs in as shown in Figure 2. Wiring Diagram.
4. Feed return JVA wire through the black extra low voltage wiring grommet.
5. Plug return JVA connection into the center socket.

## Section 6. System Setup, Programming and Testing

All system programming and installation setup is performed through the AquaLink TRI user interface UI (even when connected to iAquaLink which only allows for basic programming and functionality).

**NOTE:** For a complete list of all menu commands and functions, refer to the Owner’s Manual.

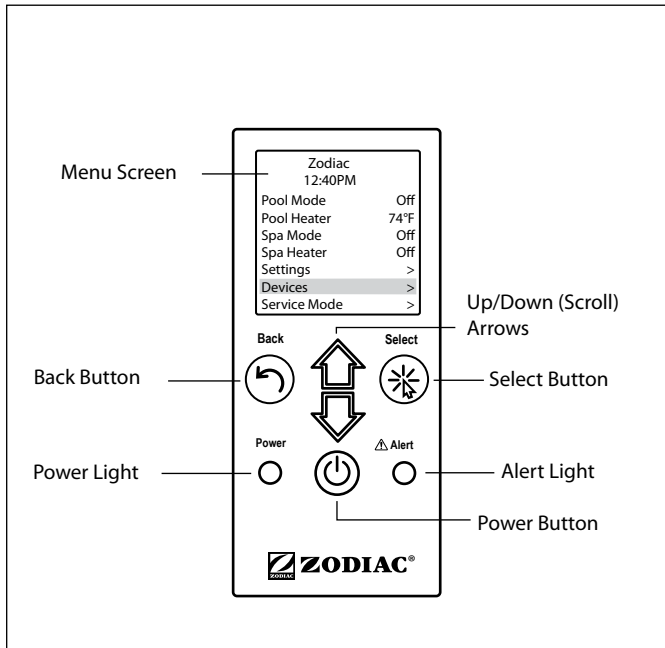





Figure 6. User Interface

### 6.1 Basic Navigation

Use the following buttons on the user interface to access and select all menus and commands:

 **On/Off**  
Turn user interface power on/off.

 **Up/Down**  
Scroll up/down within current menu to highlight a specific menu command.

 **Back**  
Go back to previous menu. To return to Main menu, press Back button repeatedly.

 **Select**  
Select current highlighted menu command. Display the next menu or activate the selected function.

### 6.2 Set the System Type

MAIN > SETTINGS > SYSTEM TYPE MENU

**NOTE** This option is only available on AquaLink TRI PS and PSi configurations.

Define the system type (Pool/Spa or Pool only) through the Service Menu. The System Type Menu is hidden.

- Highlight SETTINGS, then press and hold Select for ten (10) seconds.

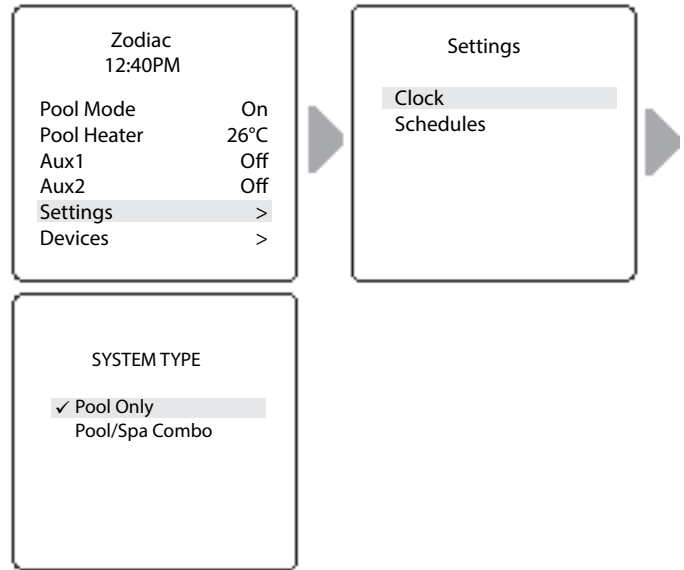

### 6.3 Set the Clock

MAIN > SETTINGS > CLOCK

Set the current day of the week and time. This setting is the basis for defining schedules for the filter pump.

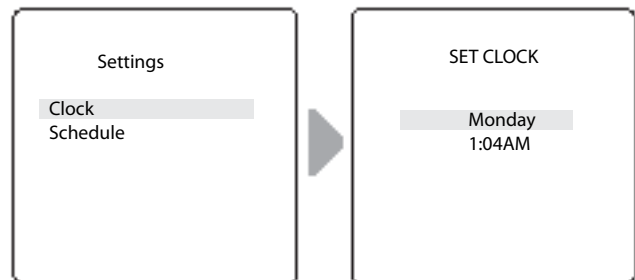

1. Highlight CLOCK and press Select twice. Current programmed day flashes.
2. Scroll up/down to display desired Day, then Select.
3. Scroll down to display current programmed time. Press Select. Current programmed hour flashes.
4. Scroll up/down to display desired hour, then Select. Current programmed minutes flash.
5. Scroll up/down to display desired minutes, then Select.

## 6.4 Define Equipment ON/OFF Schedules

MAIN > SETTINGS > SCHEDULES

Define automatic ON and OFF times for equipment. You may set different schedules for any single day, weekdays, weekends, or all days for any of the following equipment:

- Filter Pump
- Variable Speed Pump Preset (if applicable)
- Pool Heater
- Spa Heater (if applicable)
- Solar Heater (if applicable)
- Aux1, Aux2, and Aux3 (as applicable)

Set a maximum of ten programs per piece of equipment.

### 6.4.1 Define Filter Pump Schedule

MAIN > SETTINGS > SCHEDULES > FILTER PUMP

**NOTE:** The procedure to define or change ON and OFF times for all additional equipment is identical to defining Filter Pump schedule.

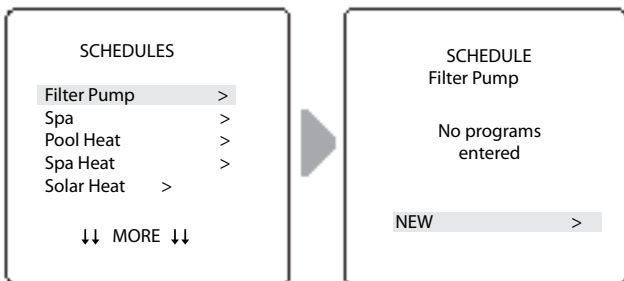

1. Highlight FILTER PUMP and press Select. No program is currently entered.
2. Highlight NEW and press Select. Current ON time is displayed.
3. Use Up/Down arrow keys to program hours and minutes for desired ON time.
4. Repeat the steps to program hour and minutes for OFF time.
5. Repeat the steps to program desired DAYS. Default setting is ALL DAYS.

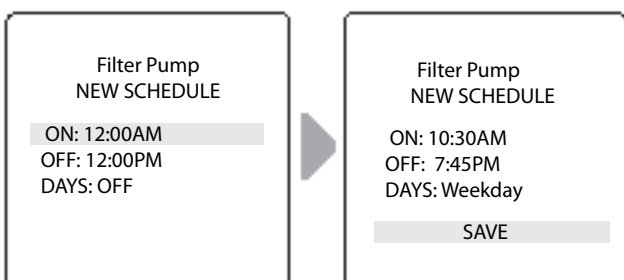

6. Scroll down to SAVE. Press Select.

## 6.5 Test the AquaLink TRI

Perform a basic installation test to make sure the controller turns on the filter pump, the pool heater, and spa pump and spa heater (if applicable). Test the controller installation using the Manual Control menu to turn specific equipment ON/OFF manually.

### 6.5.1 Test Filter Pump ON/OFF

MAIN > DEVICES > FILTER PUMP

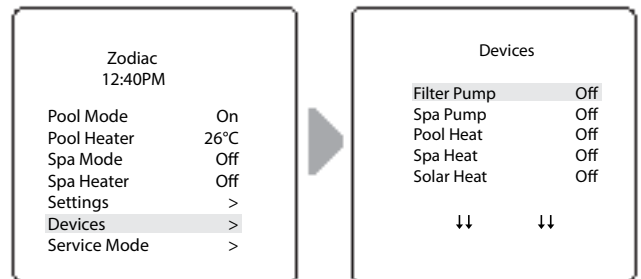

- Highlight FILTER PUMP and press Select to turn the filter pump ON. After a couple of minutes, you should hear the filter pump go on.

### 6.5.2 Test Spa Pump ON/OFF (if applicable)

MAIN > DEVICES > SPA PUMP

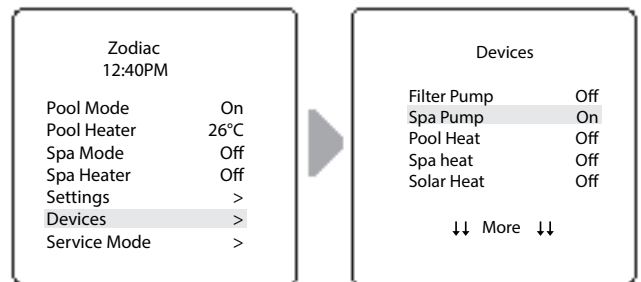

- Highlight SPA PUMP and press Select to turn the spa pump ON. After a couple of minutes, you should hear the spa pump go on.

### 6.5.3 Test Pool Heater ON/OFF

MAIN > DEVICES > POOL HEATER

1. Highlight POOL HEATER and press Select.
2. Scroll up/down to set temperature then press Select. After a couple of minutes, you should hear the pool heater go on.

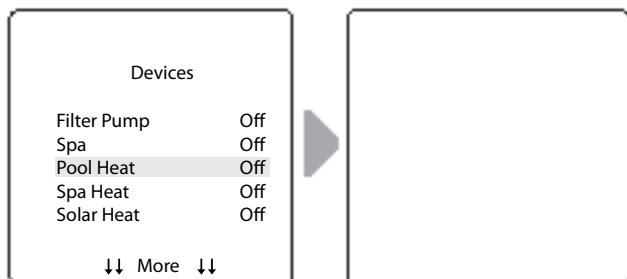

### 6.5.4 Test Spa Heater ON/OFF (if applicable)

**NOTE:** To test the spa heater installation, first turn on the auxiliary JVA associated with the spa (see *Section 7.10 Assign JVA*) and wait 35 seconds before turning on the spa heater through the UI.

MAIN > DEVICES > SPA HEATER

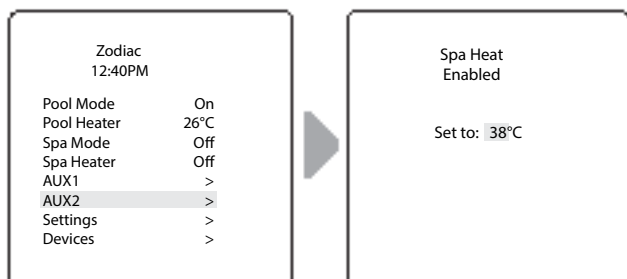

1. Highlight SPA HEATER and press Select.
2. Scroll up/down to set temperature then press Select. After a couple of minutes, you should hear the spa heater go on.

## Section 7. Install Settings

Install Settings is a hidden menu, mostly used for setup and reference purposes.

Settings available through this menu:

- **Freeze Protect**  
Automatically turn specific equipment on to protect against freezing temperatures.
- **Units**  
Change units of measurement displayed on the User Interface (temperature and time format).
- **Language**  
Change language displayed on the User Interface.
- **Clear Memory**  
Clear all programmed data in the controller for all equipment.
- **Pump**  
Assign a one-speed, two-speed pump or variable-speed pump to the controller.
- **Color Lights**  
Only available if specific lights are installed in your configuration.
- **Label Aux**  
Assign custom labels to auxiliary equipment, such as an air blower, cleaner, solar pump, etc.
- **Temp Calibrate**  
Adjust temperature displayed on the User Interface up or down by four (4) degrees.
- **Solar Priority**  
Only available if solar heating is installed in your system.
- **Assign JVA**  
Assign Jandy Valve® Actuators (JVAs) to specific AUX relays, as intake or return in Pool Only mode.
- **Ext. SWC Power**  
Only available if a compatible salt water chlorinator (SWC) is installed in your configurations.
- **Assign Hotkeys**  
Only available if AquaPalm™ is installed with your configuration.
- **Diagnostics**  
Display software revision information and alerts for troubleshooting purposes.

### To access the Install Settings Menu:

- Press and hold Up/Down arrow keys at the same time for about 5 seconds.

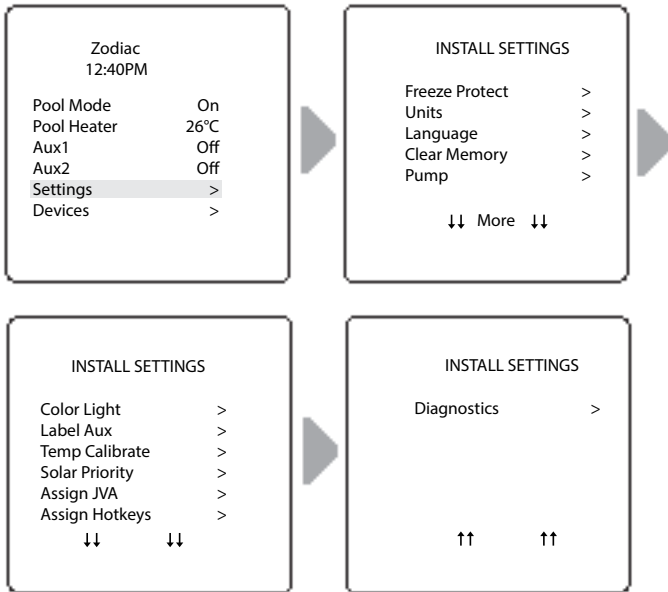

### 7.1 Freeze Protect

**NOTE** By factory default the filter pump circuit is freeze protected. During freeze protection, the filter pump cannot be turned off.

#### IMPORTANT

Freeze protection is intended to protect equipment and plumbing for short periods of freezing only. It does this by activating the filtration pump and circulating the water to prevent freeze inside equipment or plumbing. Freeze protection does **not** guarantee that equipment will not be damaged by extended periods of freezing temperatures or power outages. In these conditions, the pool and spa should be shut down completely (e.g. drained of water and closed for the winter) until warmer weather exists.

#### CAUTION

Activating the spa during freezing conditions will override freeze protection. This means that if you are using your spa when freezing conditions exist, freeze protection will **not** circulate water to non-spa related equipment that you may have freeze protected (e.g. pool cleaner, booster pump.) Under these circumstances, the potential for equipment damage may exist.

### Set Temperature:

*INSTALL SETTINGS > FREEZE PROTECT > SET TEMP*

Set outside temperature at which freeze protect function is activated. Activation temperature can be adjusted between 2°C and 5°C Default freeze protection activation temperature is 3°C. The freeze protected equipment will turn off when the temperature increases 1° C above the activation temperature.

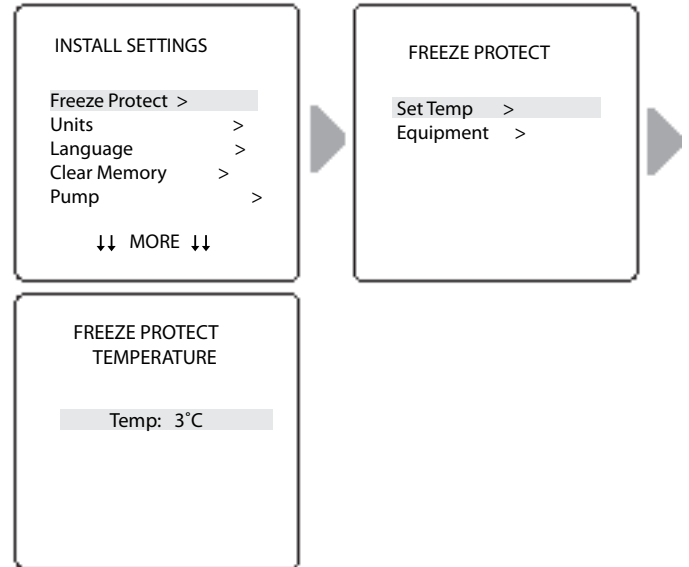

### Select Equipment:

*INSTALL SETTINGS > FREEZE PROTECT > EQUIPMENT*

Assign freeze protection to a selected piece of equipment.

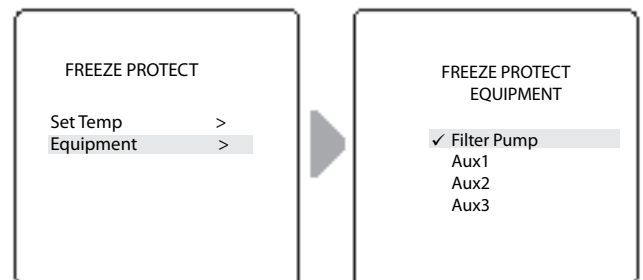

## 7.2 Units

### INSTALL SETTINGS>UNITS

Change the temperature units (Fahrenheit - Celcius) and time format (12-hour AM/PM or 24-hour clock).



## 7.3 Languages

### MAIN/STATUS>MENU>SYSTEM SETUP>LANGUAGE

Change the language displayed on the user interface. Languages available are:

- English
- Espanol
- Deutsch
- Nederlands
- Francais
- Italiano
- Portuguese
- Afrikaans

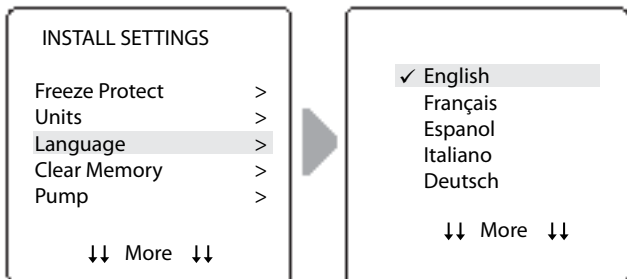

## 7.4 Clear Memory

### INSTALL SETTINGS>CLEAR MEMORY

Clear all stored values (e.g., auxiliary labels, programs, remote settings, and thermostat settings) from the AquaLink TRI memory. All settings will be reset to default factory settings. Time and date is not cleared.

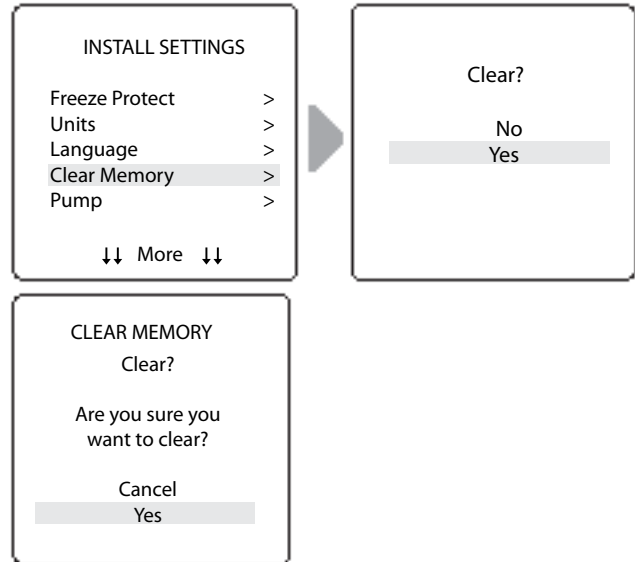

- The system asks you to verify you are sure you want to clear memory.
- There is a 15-second delay and \*MEMORY CLEARED\* message is displayed.

## 7.5 Pump

Assign the pump type currently installed in your system, either one or two-speed, or variable speed.

### Select 1-Speed or 2-Speed Pump:

#### INSTALL SETTINGS > PUMP > 1-SPEED / 2-SPEED

Assign either one-speed or two-speed pump On/Off.

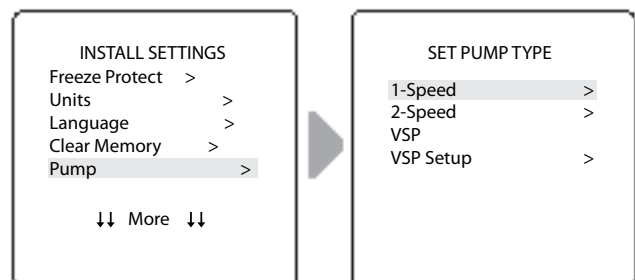

- A check mark next to the pump name indicates it is currently selected.



### Select Variable Speed Pump (VSP):

INSTALL SETTINGS > PUMP > VSP > VSP SETUP

Select the variable speed pump type installed and select the various pump speed settings and minimum/maximum speed limits.

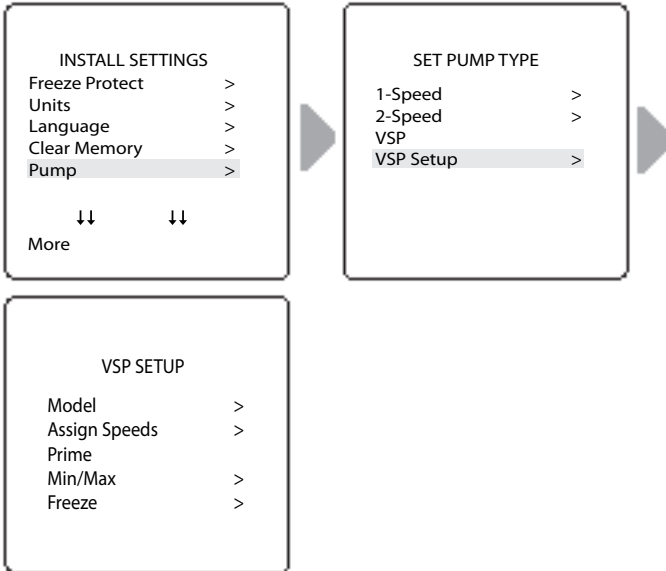

- For any Jandy brand pump, select Jandy/Zodiac.
- For other branded variable speed pumps, check the manufacturer’s details for compatibility.

### 7.6 Color Lights

INSTALL SETTINGS > COLOR LIGHTS

**NOTE** You will only see this option if colored lights are installed in your system.

Select type of light installed (e.g., Jandy® Colors™ or Jandy® LED Light) and assign the light to an available auxiliary relay. Please note for Australia Pacific region all Jandy and/or Zodiac lights use the same setting.

#### Select Light Type:

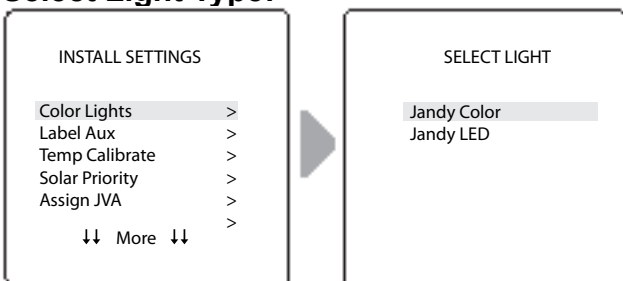

### Assign Selected Light to an Auxiliary:



- JC is displayed next to AUX if a Jandy Colors light has been assigned.
- JL is displayed next to AUX if a Jandy LED Light has been assigned.
- Press Select button with JC or JL highlighted to toggle control by the auxiliary on or off.

### 7.7 Label Auxiliary Functions

INSTALL SETTINGS>LABEL AUX

Assign labels to auxiliary equipment to display text in the user interface instead of AUX 1, 2, or 3.

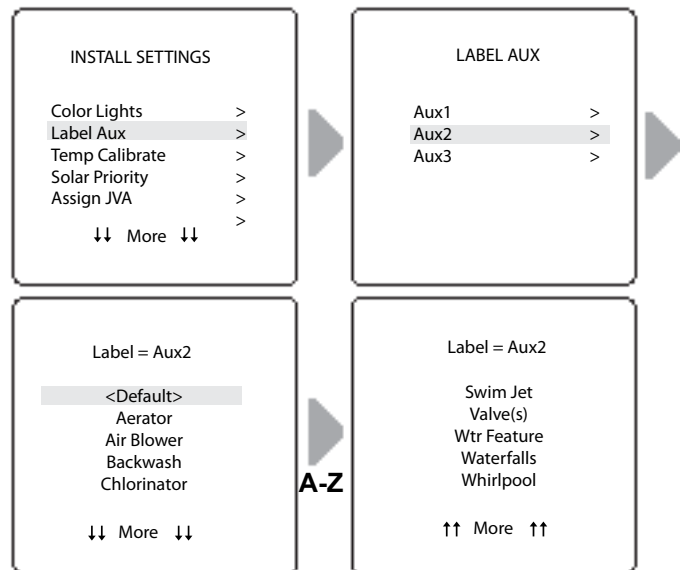

- Choose from labels listed A-Z on each screen.

**NOTE** “SPILLOVER” assigns AUX to invoke Spillover Mode only in AquaLink TRI PS or PSi configurations.

## 7.8 Temp Calibrate

### INSTALL SETTINGS>TEMP CALIBRATE

Adjust temperature displayed on the AquaLink TRI up or down by 2 degrees.

**NOTE** If the temperature is off by more than two (2) degrees, contact your local service representative.

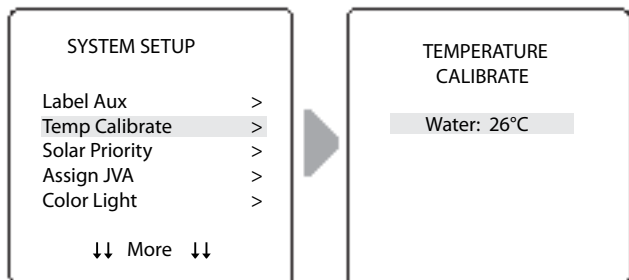

- Use Up/Down arrows to set new temperature value.

## 7.9 Solar Priority (if applicable)

### INSTALL SETTINGS>SOLAR PRIORITY

**NOTE:** You will only see this option if solar heating is installed in your system.

Enable the system to use solar heat first, when available. If solar heat is no longer available, the system will automatically switch to the alternate heat source.

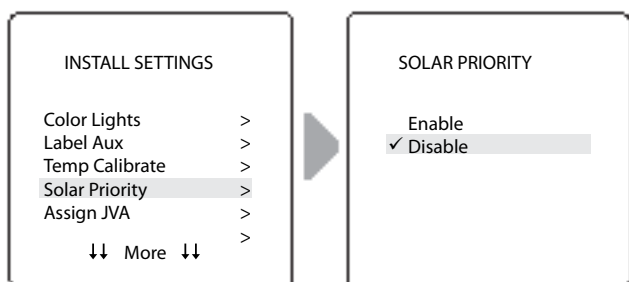

- When solar and heater are enabled the solar will heat the water until either the thermostat setting has been reached or solar heat is no longer available.
- If the solar panel is not hot enough, solar heat will shut off and the other heat source (usually gas heater) will take over to bring the water up to the thermostat setting.

## 7.10 Assign JVA

### INSTALL SETTINGS>ASSIGN JVA

**NOTE:** If the system is a pool/spa combination, without solar, only the solar JVA is assignable. If the system is a pool or spa only system, without solar, all three JVAs are assignable. The example shown is for a pool or spa only system without solar.

Allow Jandy® Valve Actuators (JVAs) to be assigned to any auxiliary on the AquaLink TRI controller, so that when you select this auxiliary, the valve turns. Assigning JVAs lets the pool owner control certain features like diverting water to a waterfall or bank of spa jets. Multiple JVAs can be assigned to one auxiliary without extra hardware.

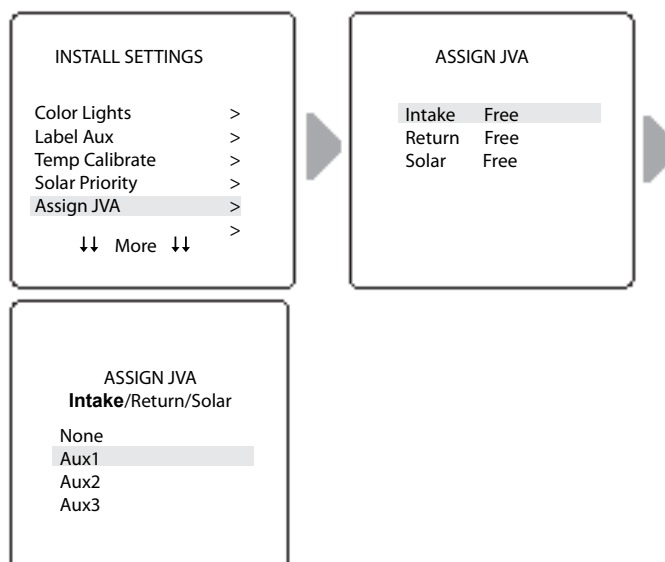

### 7.11 Assign Hotkeys

INSTALL SETTINGS>ASSIGN HOTKEYS

**NOTE:** You will only see this option if the AquaPalm™ is installed in your system and is turned on.

Assign buttons 1 and 2 on the AquaPalm handheld remote to any piece of equipment connected to a circuit or relay for immediate and dedicated control of that equipment.

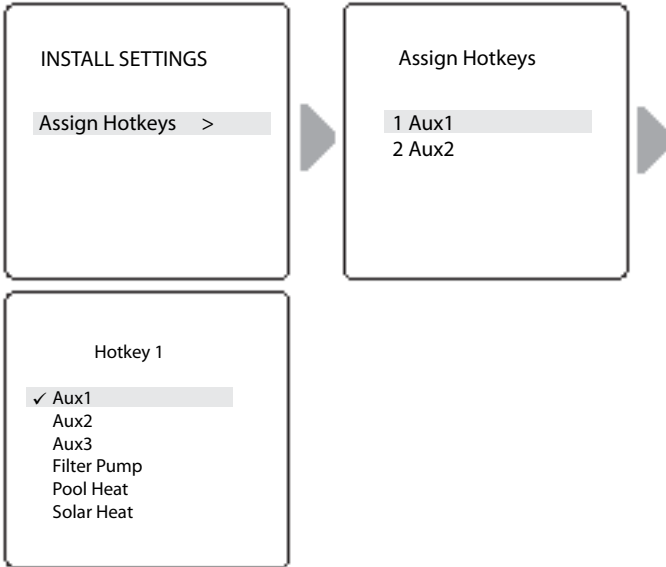

### 7.12 Ext. SWC Power

INSTALL SETTINGS>EXT. SWC POWER

**NOTE:** You will only see this menu if SWC is connected to your system.

Route saltwater chlorinator system (SWC) power through one of the auxiliary relays.

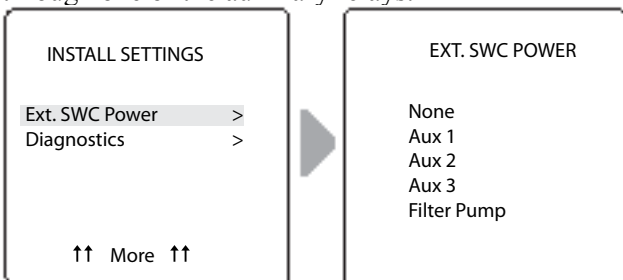

### 7.13 Diagnostics

INSTALL SETTINGS>DIAGNOSTICS

For troubleshooting purposes, view diagnostic information relating to current firmware revisions, system alerts or error messages, and status of devices connected to the RS-485 controller.

#### View Revision Number:

INSTALL SETTINGS>DIAGNOSTICS>REVISIONS

View your system firmware revision number for troubleshooting.

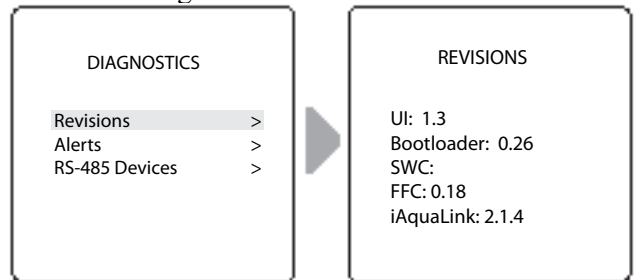

#### View Alert Messages

INSTALL SETTINGS>DIAGNOSTICS>ALERTS

View alerts or error messages. See *Section 10. Glossaries* for a complete list and explanation of all system messages.

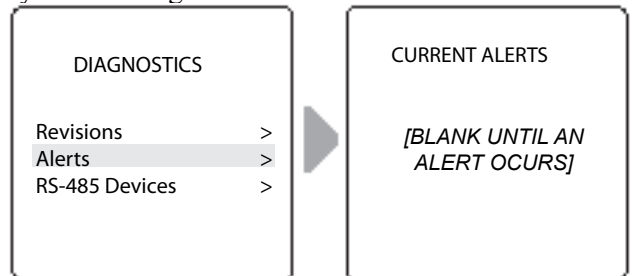

- Screen is blank if the controller has no errors to report.

#### View RS-485 Device Status:

INSTALL SETTINGS>DIAGNOSTICS>RS-485 DEVICES

View status of devices connected to the RS-485 controller. Depending on your equipment configuration, any combination of the following equipment may be displayed:

- FFC - AquaLink TRI Controller
- iAL - iAquaLink
- SWC - Salt Water Chlorinator
- VSP - Variable Speed Pump

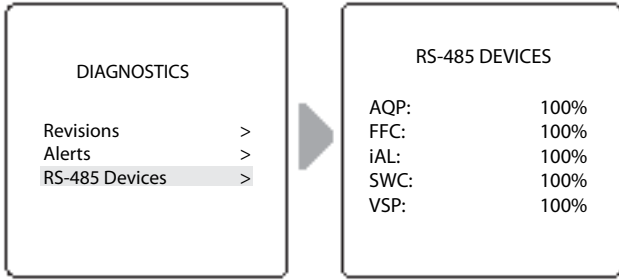

## Section 8. Service Mode

MAIN>SERVICE MODE

Service Mode is used for safety purposes to shut off power to all equipment during service or troubleshooting.

Settings available through this menu:

- Auto**  
 Indicates that equipment is turned on and running according to system programming.
- Service**  
 Indicates that all equipment is turned off until system is manually turned to Auto by service technician.
- Timeout**  
 Indicates that all equipment will remain turned off for three (3) hours and then resume running according to system programming after that time period.

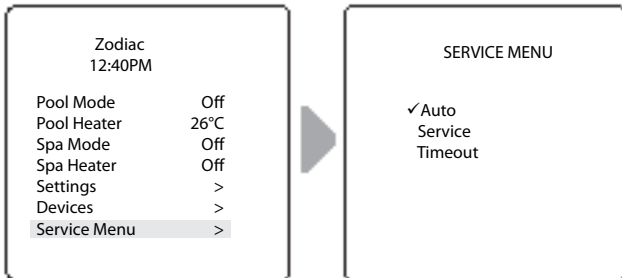

## Section 9. Pool/Spa System Menu Flow Diagrams

### 9.1 Main Menu

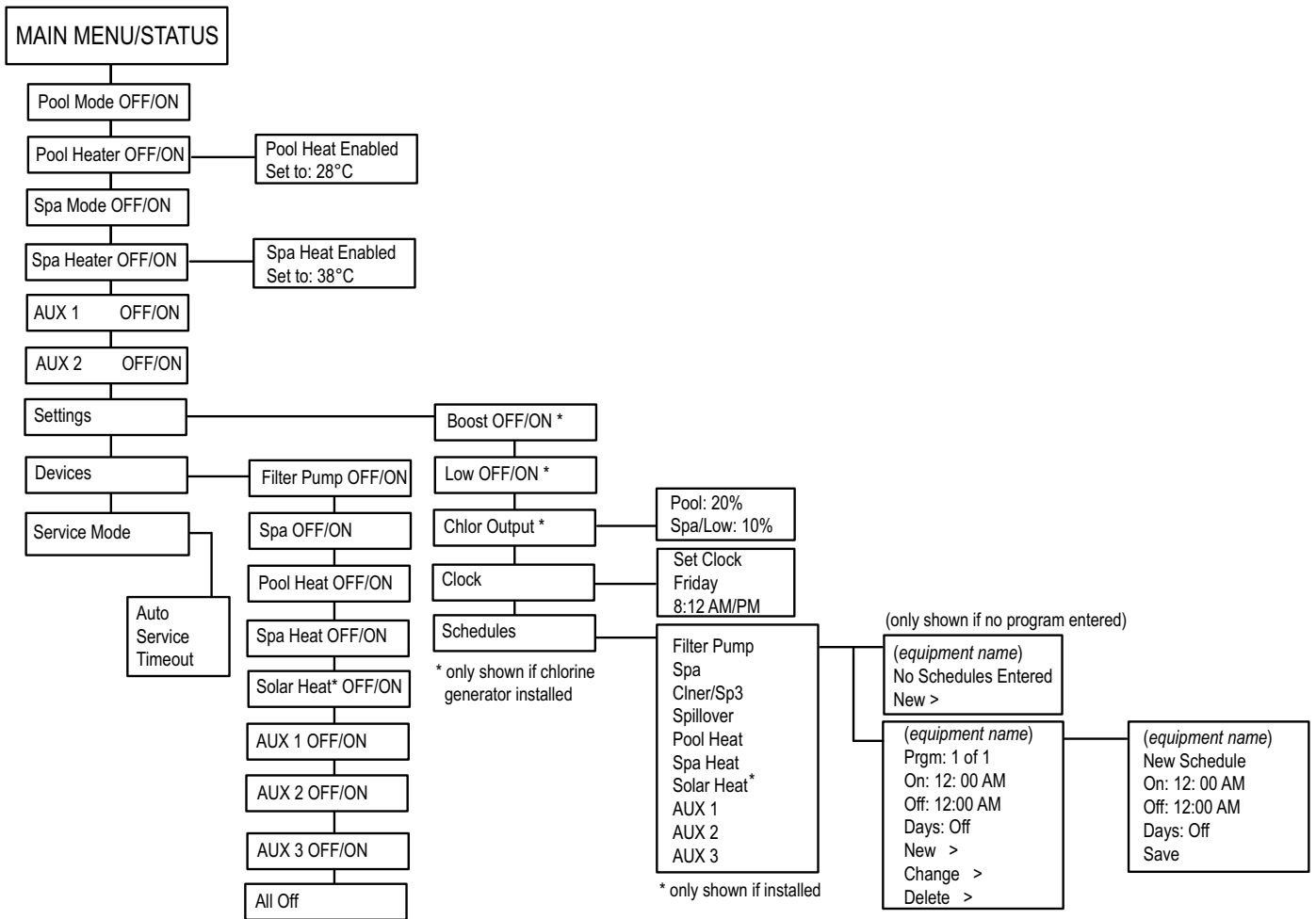

## 9.2 Install Settings Menu

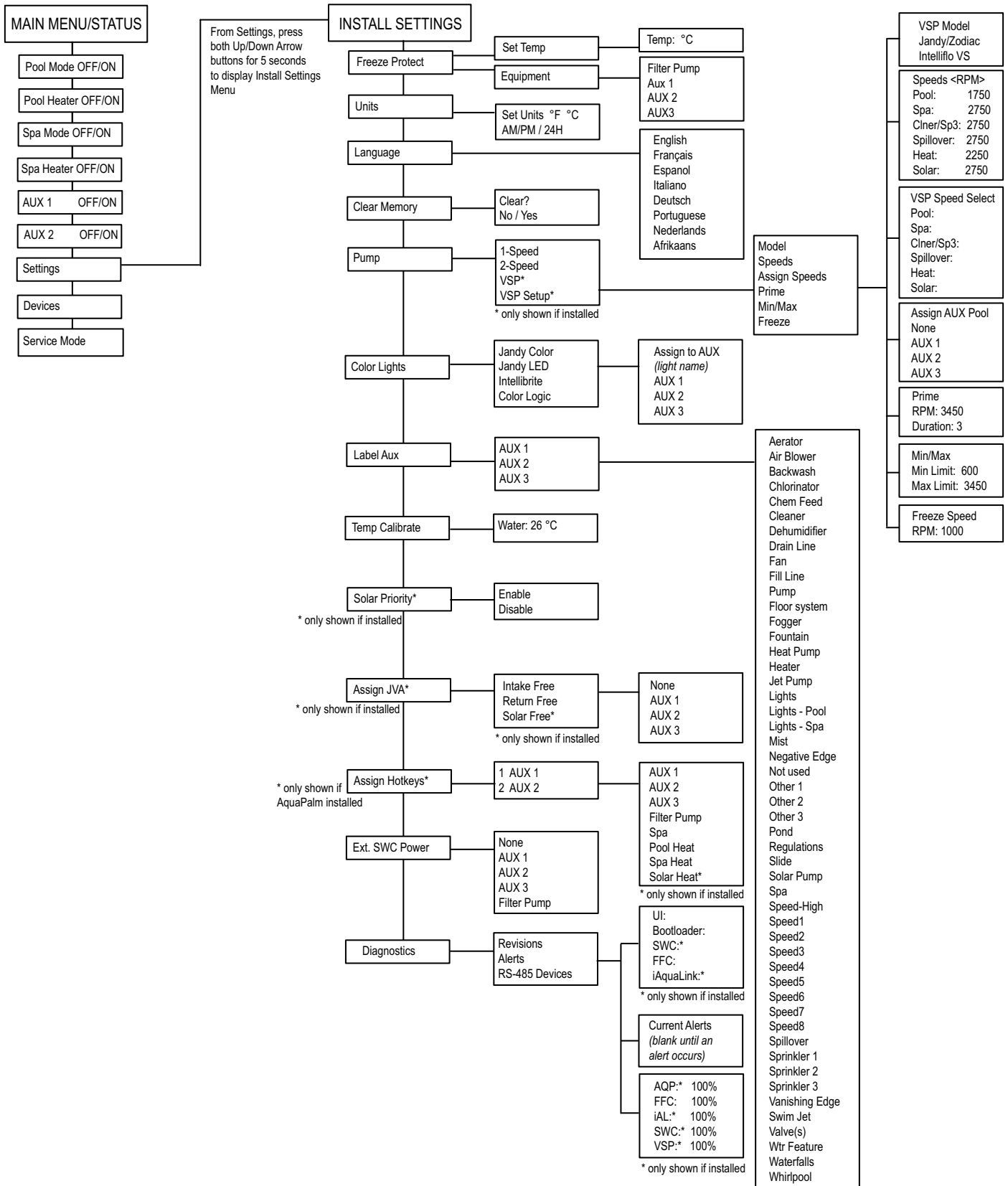

## Section 10. Pool Only System Menu Flow Diagrams

### 10.1 Main Menu

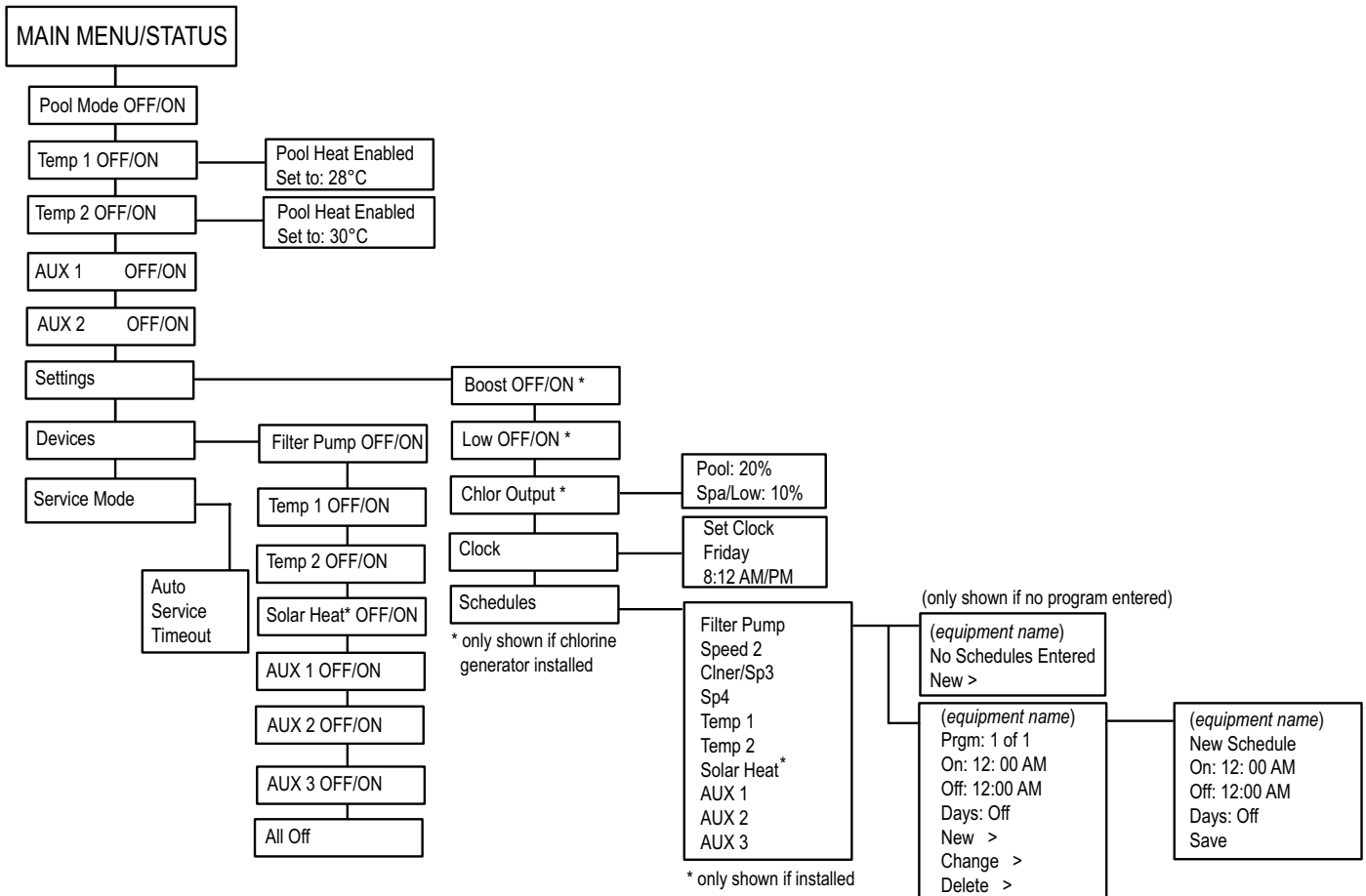

## 10.2 Install Settings Menu

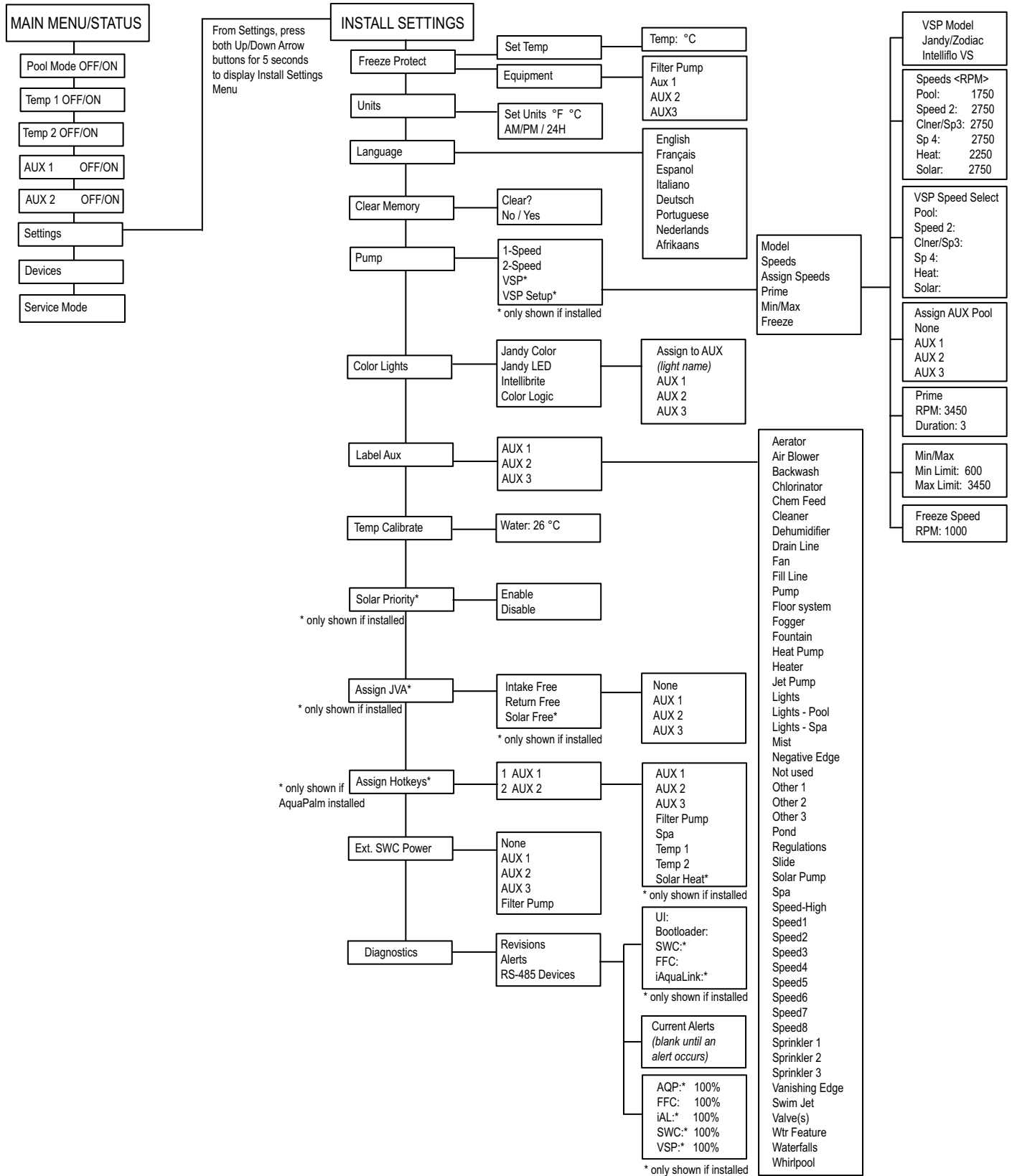



## Section 11. Glossaries

### 11.1 Glossary of Safety Delays and Lockouts

#### Lockouts

Any device can be locked out. This will prevent the locked out device from being turned on manually. However, the device will turn on/off when it is being controlled by a schedule.

#### Pool/Spa Switching Filter Pump Delay

The filter pump turns off while valves rotate between pool and spa to prevent damage to the pool equipment. The valves take 35 seconds to rotate between pool and spa; the filter pump will activate as soon as the valves have finished turning.

#### Heater Cool Down Delay

When the system is heating (water is circulating to the spa) and the Spa button is pressed, the system will remain in Spa Mode for five (5) minutes, and will continue to circulate the water. This delay allows water to cool the heater down by circulating water through it, preventing equipment damage. The five (5) minute delay starts counting down when the heater goes off. If the heater has been off for five (5) minutes or more, prior to turning off the Spa, there will not be a delay.

#### Heater Start-up

The heater will only come on if the water is circulating (for example, the filter pump is on and has been circulating for 15 seconds) to the corresponding body of water (for example, spa for spa heater) and the actual water temperature is below the temperature you set with Temp Set in the Menu. If these conditions are not met, the heater will be enabled (ready to go), but will not fire.

#### Heater “Short Cycling” Prevention

When the heater is activated and the desired temperature is reached, heater will turn off and remain off for three (3) minutes, even if the temperature falls below the desired temperature. This feature prevents heater short cycling (in other words, the heater turning off and on in rapid succession).

#### Cleaner Lockout

The pool cleaner will only activate if the system is in pool mode and water is circulating. The pool cleaner requires that water is circulating to the pool in order for it to operate. Return to pool mode to activate the cleaner.

#### Spillover Lockout

The spillover will only activate if the system is in pool mode and water is circulating. The spillover requires that water is circulating to the pool in order for it to operate. Return to pool mode to activate the waterfall. Also, if the pool cleaner is on, it will turn off during spillover operation.

#### Spillover

The spillover is disabled while the spa is on. A message is displayed when spillover is turned on while in spa mode (water is circulating to spa). The spillover requires that water circulation is to pool in order to operate. The spillover will activate when the system switches back to pool mode.

#### Enabled

When activated allows the function to work.

#### Disabled

When activated does not allow the function to work.

### 11.2 Glossary of Alert Messages

#### **CLEANER CANNOT BE TURNED ON WHILE SPA IS ON**

This message is displayed if the pool cleaner is activated when in spa mode and water is circulating to the spa. The pool cleaner requires that water be circulating to the pool in order for it to operate. Return to pool mode to activate the cleaner.

#### **CLEANER CANNOT BE TURNED ON WHILE SPILLOVER IS ON**

The return valve has been rotated to the spa position to give the spillover effect.

## **FREEZE PROTECT**

This message indicates that freezing conditions have been detected by the freeze protection sensor, and that equipment assigned to freeze protection are active (for example, the filter pump). See *Freeze Protection Menu* for more information.

**NOTE** The filter pump is always protected; spa and auxiliary circuits can be assigned to freeze protection. If a freeze protected Auxiliary is turned off during freeze protection, a message will be displayed indicating that item is off but will turn on in X amount of minutes. The minutes will vary depending on how long freeze mode has been active from one (1) to 15 minutes.

## **SENSOR OPEN**

This error message indicates that the sensor is not installed properly or is malfunctioning. Call your pool service person to resolve this problem.

**NOTE** If the message reads WATER TEMP OPEN, the heater will not fire. If message AIR TEMP OPEN is displayed, freeze protection will not operate correctly.

## **POOL HEATER ENABLED**

This message indicates that the pool heater is ready to use but is not actually firing. The filter pump must be on, and the water temperature must be below the setting for the heater to fire.

## **PUMP WILL REMAIN ON WHILE SPILLOVER IS ON**

This message is displayed when you attempt to turn off the filter pump while a spa spillover is on. Since the filter pump is necessary for spillover operation, the pump will remain on until the spillover is turned off.

## **PUMP WILL TURN OFF AFTER COOL DOWN CYCLE**

This message indicates that the filter pump is circulating water to cool down the heater. The filter pump will continue to run for five minutes to protect the heater from damage, whenever the heater has fired and has been off for less than five (5) minutes.

## **PUMP WILL TURN ON AFTER DELAY**

This message is displayed during pool/spa switching. The AquaLink TRI waits 35 seconds while the valves turn from pool position to spa position (or vice-versa) before activating the filter pump.

## **SERVICE MODE**

Service mode is used by the pool service person to aid them in servicing the pool.

## **SENSOR SHORT**

This error message indicates that the sensor is not installed properly or is malfunctioning. Call your pool service person to resolve this problem.

**NOTE** If the message reads WATER TEMP SHORT, the heater will not fire. If the message AIR TEMP SHORT is displayed, freeze protection will not operate correctly.

## **SPA WILL TURN OFF AFTER COOL DOWN CYCLE**

When the system is in Spa Mode (water is circulating to the spa) and the Spa button is pressed to switch water circulation to the pool, the system will not switch to Pool Mode for five (5) minutes, and will continue to circulate the water (if the heater has fired and has been off for less than five minutes). This delay allows water to cool the heater down by circulating water through it, preventing equipment damage.

## **TIMEOUT MODE**

TIME OUT mode is used by the pool service person to aid them in servicing the pool. The AquaLink® user interface will not be functional for three (3) hours, or until the switch at the Controller is turned back to AUTO mode. The time remaining for TIME OUT mode is displayed on the user interface screen.

## **SPILLOVER DISABLED WHILE SPA IS ON**

This message is displayed when the spa spillover is pressed while in spa mode (water circulation is to spa). The spillover requires that water circulation is to pool in order to operate. The spillover will activate when the system switches back to pool mode.

## NOTES

**Fluidra Group Australia**  
219 Woodpark Road,  
Smithfield NSW2164, Australia  
1.300.763.021 | [www.zodiac.com.au](http://www.zodiac.com.au)

*ZODIAC® is a registered trademark of Zodiac International,  
S.A.S.U., used under license.  
All trademarks referenced herein are the property of their respective owners.*

©2013 Zodiac Pool Systems, Inc. H0391100 REV B 1309

