



QUAD ELEMENT CARTRIDGE FILTER

Installation and Operation



USER MANUAL

Models: GX400

TABLE OF CONTENT

PAGE	2 IMPORTANT SAFETY INSTRUCTIONS
	3 1. OVERVIEW
		1.1 PRODUCT INFORMATION
		1.2 DIMENSIONS
	4 2. INSTALLATION
	5 3. STARTING THE PUMP AND FILTER SYSTEM
		3.1 BEFORE STARTING THE PUMP
		3.2 STARTING PUMP
		3.3 OPERATION
	7 4. MAINTAINING YOUR FILTER
		4.1 FILTER DISASSEMBLY INSTRUCTION
		4.2 REMOVING CARTRIDGES
		4.3 CLEANING CARTRIDGES
		4.4 FILTER REASSEMBLY INSTRUCTION
		4.4.1 RE-INSTALLATION CARTRIDGES
		4.4.2 CLEAN SEAL RING AND SEAL SURFACE
		4.4.3 BODY AND CLAMP REASSEMBLY
		4.4.4 VACUUMING POOL
		4.5 REMOVING THE AIR RELIEF VALVE
		4.5.1 RE-INSTALLATION OF THE AIR RELIEF VALVE
	10 5. WINTERIZING FILTER
	10 6. TROUBLE SHOOTING
		6.1 WATER CHEMISTRY
	11 7. SPARE PART LIST
	12 8. TERMS OF THE WARRANTY

IMPORTANT SAFETY INSTRUCTIONS



THESE OPERATING INSTRUCTIONS CONTAIN IMPORTANT INFORMATION ON THE SAFE, PROPER, AND ECONOMICAL OPERATION OF THIS SWIMMING POOL APPLIANCE. STRICT OBSERVATION OF THE OPERATING INSTRUCTIONS WILL HELP TO AVOID DANGERS, REDUCE REPAIR COSTS, AND SHUTDOWN TIMES AND INCREASE THE RELIABILITY AND WORKING LIFE OF THE PRODUCT.

Failure to follow the instructions in this manual may result in serious adverse health effects or even serious or fatal injury. Failure to follow the instructions in this manual will in all cases invalidate all guarantees and liability on the part of the manufacturer.

Consumer Information and Safety

These Cartridge Filters are designed and manufactured to provide years of safe and reliable operation. Operated and maintained according to the information in this manual and the installation codes referred to in later sections.

THIS FILTER OPERATES UNDER HIGH PRESSURE

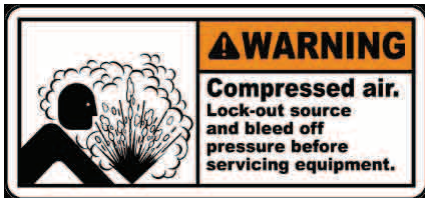

When any part of the circulating system, (e.g., closure, pump, filter, valve(s), etc.), is serviced, air can enter the system and become pressurized. Pressurized air can cause the top closure to separate which can result in severe injury, death, or property damage. To avoid this potential hazard, follow these instructions:

1. If you are not familiar with your pool filtering system:
 - (1) Do NOT attempt to adjust or service without consulting your dealer, or a qualified pool technician.
 - (2) Read the entire Installation & Operation Manual before attempting to use, service, or adjust the pool filtering system.
2. Before repositioning valve(s) and before beginning the assembly, disassembly, or any other service of the circulating system:
 - (1) Turn the pump OFF and shut OFF any automatic controls to ensure the system is NOT inadvertently started during the servicing;
 - (2) Open the air relief valve;
 - (3) Wait until all pressure is relieved.
3. Whenever installing the filter closure follow the filter closure warnings exactly.
4. Once service on the circulating system is complete follow initial start-up instructions exactly.
5. Maintain circulation system properly. Replace worn or damaged parts immediately, (e.g., closure, pressure gauge, valve(s), O-rings, etc.).
6. Be sure that the filter is properly mounted and positioned according to the instructions provided.



WARNING:

This filter must be installed by licensed or certified electrician or qualified pool serviceman in accordance with the Local Code and all applicable local codes and ordinances.

Improper installation could result in death or serious injury to pool users, installers, or others and may also cause damage to property.

Always disconnect power to the pool circulating system at the circuit breaker before servicing the filter. Ensure that the disconnected circuit is locked out or properly tagged so that it cannot be switched on while you are working on the filter. Failure to do so could result in serious injury or death to a serviceman, pool user, or others due to electric shock.

READ UNDERSTAND AND FOLLOW ALL SAFETY AND OPERATION:



Do not operate the filter until you have read and understand clearly all the operating instructions and warning messages for all equipment that is a part of the pool circulating system. The following instructions are intended as a guide for initially operating the filter in a general pool installation. Failure to follow all operating instructions and warning messages can result in property damage or severe personal injury or death.



To reduce the risk of injury, do not permit children to use this product.



ELECTROCUTION HAZARD

Direct water discharge from air relief valve away from electrical service. Do not locate pump control over near the filter.

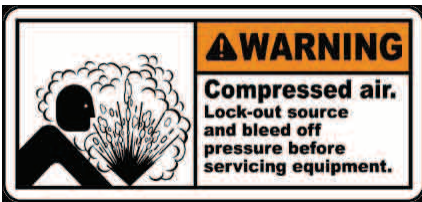

Due to the potential risk that can be involved, it is recommended that the pressure test be kept to the minimum time required by the local code. Do not allow people to work around the system when the circulation system is under the pressure test. Post appropriate warning signs and establish a barrier around the pressurized equipment. If the equipment is located in an equipment room, lock the door and post a warning sign.

Never attempt to adjust any closures or lids or attempt to remove or tighten bolts when the system is pressurized. These actions can cause the closure to separate and could cause severe personal injury or death if they were to strike a person.

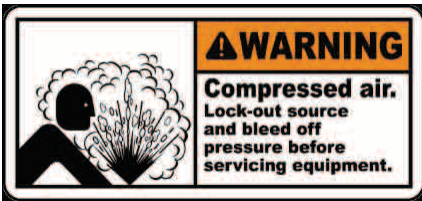

Never exceed the maximum operating pressure of system components. Exceeding these limits could result in a component failing under pressure. This instantaneous release of energy can cause the closure to separate and could cause severe personal injury or death if they were to strike a person.



HYPERTHERMIA

SPA water temperature excess of 38°C (104°F) may be injurious to health. Measure water temperature before entering SPA to strike a person.

Hyperthermia occurs when the internal temperature of the body reaches a level several degrees above the normal body temperature of 98.6 °F (37 °C). The symptoms of hyperthermia include drowsiness, lethargy, and an increase in the internal temperature of the body.

1. OVERVIEW

GX series cartridge filter combines superior water filtration with ease of operation and corrosion-free construction. With filtration ratings of 5,100~ 8,910 gallons (19,305 ~ 33,700 liters) per hour, they are designed for continuous or intermittent operation, for installation above or below the pool waterline, for fresh or saltwater swimming pools or spas. ICF series filters utilize multiple reusable, reinforced polyester filter cartridge elements to provide a high degree of water clarity and long filter cycles with minimum care.

1.1 PRODUCT INFORMATION

Model	EFFECTIVE FITRATION AREA		DESIGN FLOW RATE	
	FT ²	M ²	Residential GPM	Commercial LPM
GX430	430	39.97	150	575

[Filter rate for commercial use at 0.375 GPM/ft². Recommend Flow Rate for 2" piping is 90 ≤ x ≤ 150 GPM]

1.2 DIMENSIONS

Model	A		B		C		D	
	IN	CM	IN	CM	IN	CM	IN	CM
GX430	20.9	53	18	45.6	23.7	60.2	1.91	4.85



2. INSTALLATION

This product should be installed and serviced only by a qualified pool professional.

1. The filter system should be installed on a level concrete slab or another rigid base. Select a well-drained and vented area, one that does not flood when it rains. Position the filter so that the piping connections and winter drain are convenient and accessible for operation, service, maintenance, and winterizing.
2. Position filter body such that all operation and safety labels are visible.
3. Position filter so the filter will drain by gravity.
4. If practical, place the pump and filter in the shade to shield it from direct sunlight.
5. Connect the pool suction plumbing between the skimmer, pool outlet (from the pool), and the pump.
6. Install the plumbing from the filter to the pool (return to the pool).
7. Do not locate pump controls over or near the filter.
8. Verify water discharge from the air relief valve is directed away from electrical devices.

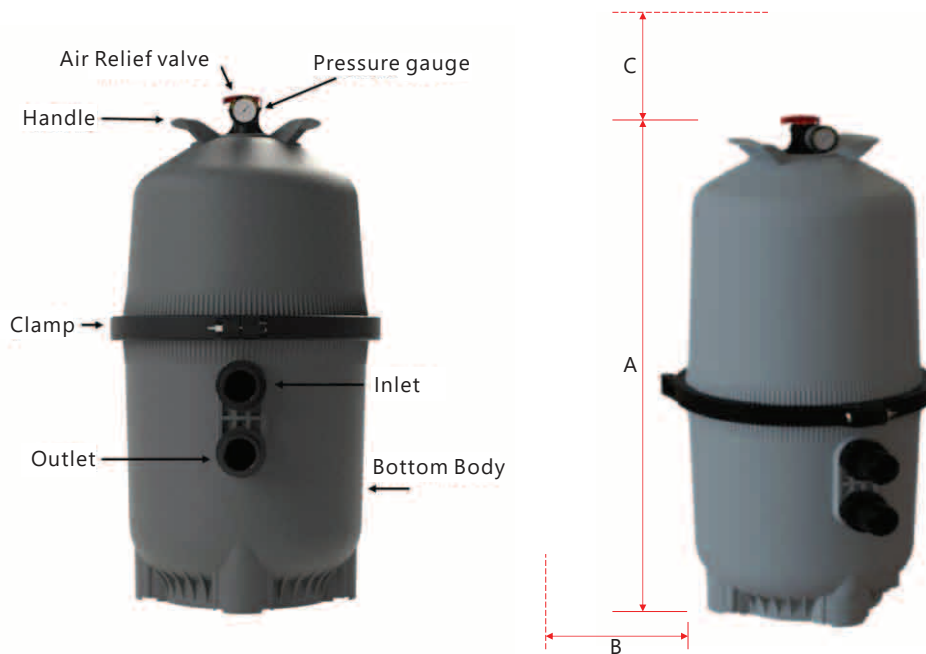

MODEL	A		REQUIRED CLEARANCE			
			"B" side		"C" above	
	IN	CM	IN	CM	IN	CM
ICF430	40.7	103.5	18.1	46	18.89	48

3. STARTING THE PUMP AND FILTER SYSTEM

3.1 BEFORE STARTING THE PUMP

1. Use ONLY GX system components; Clamp unit doing assembly, metal-reinforced seal. Non-tighten clamp components may fail in use and cause explosive component separation. Verify that upper and lower filter bodies are properly secured with the clamp unit. Make sure tightening enough the filter upper and bottom body with clamp. Verify that the filter Air relief valve is in the LOCK position, and no filter components are missing, damaged, or not genuine GX filter components.



Figure 1

2. Close the filter drain. Note: drain plug requires an O ring seal.

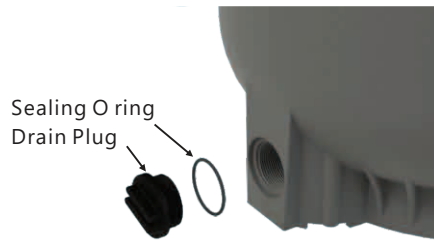

Figure 2

3. Open all system valves to allow water from the pool to the filtration system and from the filter to return to the pool.

4. Place the manual Air relief valve in an OPEN position.



Figure 3

3.2 STARTING PUMP

Stand clear of pump during start-up

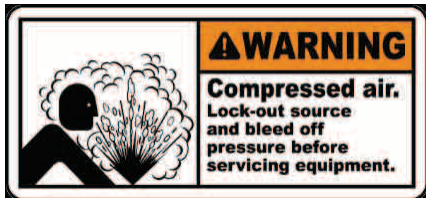

Pool and spa circulation systems operate under high pressure. When any part of the circulating system (i.e. lock ring, pump, filter, valves, etc.) is serviced, air can enter the system and become pressurized. Filter Lid and pre-filter cover must be properly secured to prevent violent separation. Place pre-filter / filter air relief valve open and wait for all pressure in the system to be relieved before remove the lid to access the basket for cleaning.

1. When starting the system pump, do not stand over or near the filter. If water leakage appears at the clamp, Turn off all system circulation pumps and all electrical power. Do not return to the filter until all water leakage has stopped. Reassemble the clamp system per the instructions of the previous page in this owner's manual.
2. Return to the filter and only CLOSE the manual air relief valve if a steady stream of water escapes from the valve and not air or an air-water mix.

3.3 OPERATION

Filtration starts as soon as the flow is steady through the filter. As the filter removes dirt from the pool water, the accumulated dirt causes a resistance to flow. As a result, the pressure will rise and the flow will decrease.

1. Record the initial starting pressure which is the initial pressure reading when a new filter element is working under filtration conditions.
2. Every time after reinstalling "new filter element" or "after cleaned filter cartridge element", make sure the system is under filtration condition, then turn the START arrow to the pressure gauge pointer position to indicate the Start pressure.



Figure 4

3. Monitor the pressure from time to time, when the pressure reading is over the Clean Filter arrow, follow step 4.2 to clean filter cartridge elements.

Replace a new filter cartridge element.

You should replace a new filter cartridge element:

1. After cleaning the filter element, if the pressure is:
 - a. 25 psi higher than the initial start ready, or
 - b. the pressure reading is over 40 psi.
2. When the filter element is broken, or the layer peels off.
3. When the pressure or flow rate is below the desired rate of the system.

4. MAINTAINING YOUR FILTER

This product should be installed and serviced only by qualified pool professional.

4.1 FILTER DISASSEMBLY INSTRUCTION

1. Turn off all system circulation pumps and all-electric power on the equipment pad.
2. Set all system valves in a position to prevent water flow to the filter.
3. The air relief valve OPEN.
4. Remove the drain plug and let water flow out from the filter.
5. Using wrenches, loosen and remove the clamp by unscrewing the clamp nut and the bolt.
6. Holding both ends of the clamp carefully then spread the clamp ends. Lifting the clamp over the upper body.
Do not drop the ring and do not strike the clamp with metal tools, the clamp could be damaged.
7. Lift off the upper body. Do not hold the pressure gauge to lift the upper body.

4.2 REMOVING CARTRIDGES

1. Remove the filter cartridge elements by using a slight rocking motion and lifting.
2. Clean filter cartridge elements.

4.3 CLEANING CARTRIDGES

The Cartridge filter element can be cleaned by washing inside and outside with a garden hose. After hosing the cartridge, carefully brush the pleated surface to remove fine particles. Do not pressure wash as it can damage the filter element.

You may find some debris on the cartridge pleats, which may not have been removed with hosing

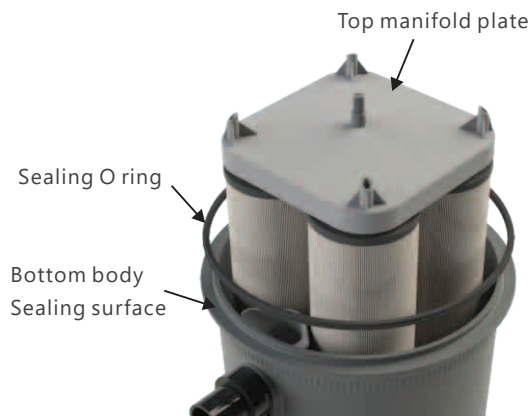

Figure 5

4.4 FILTER REASSEMBLY INSTRUCTION

4.4.1 RE-INSTALLATION CARTRIDGES

1. Flush and drain any dirt or debris from the bottom of the lower filter body.
2. Flush any dirt or debris from the upper filter body and from around the air release area.
3. Carefully replace the cartridges over the hubs on the bottom manifold.
4. Place top filter body securely on top of cartridges.

4.4.2 CLEAN SEAL RING AND SEAL SURFACE

1. Remove filter tank sealing O Ring.
2. With a clean cloth, wipe the lower filter body seal surface and clean seal of all dirt and debris. Do not use a solvent.
3. With a clean cloth wipe the upper body seal surface.

Notice: Do not use any petroleum solvents to clean filter components
Do not lubricate sealing O ring.
If the O ring is damaged, it must be replaced

4.4.3 BODY AND CLAMP REASSEMBLY

1. Place the Sealing O Ring on the lower filter body.
2. Place the upper filter body on Sealing O Ring and lower filter base in a position that allows all operation and safety labels to be visible and the upper filter body to be centered on the lower filter base. Press down firmly and evenly on the upper filter body to seat the seal.

NOTE: If the O-ring is damaged it must be replaced



Figure 6 The fluted side of the rubber Sealing O ring face down

3. Replace the filter clamp around the upper and lower filter bodies. Hold the clamp ends in position while reinstalling the bolt and nut.



Figure 7

4. Tighten the nut and bolt with a torque wrench.
DO NOT HIT OR STRIKE CLAMP WITH HAMMER OR METAL TOOLS.
5. Follow Operation Instructions for "Starting the Pump and Filter System".

4.4.4 VACUUMING POOL

Vacuumping can be performed directly into the filter whenever needed.
Clean cartridges after vacuuming if required.

4.5 REMOVING THE AIR RELIEF VALVE

The filter comes with a preinstalled manual air relief valve. Servicing the Air Relief Valve should be carried out by pool professionals only by carefully following the instructions:

1. Turn off all system circulation pumps and all-electric power on the equipment pad.
2. Set all system valves in a position to prevent water from flowing to the filter.
3. The air relief valve must be placed in the OPEN position.
4. Wait until all water leakage has stopped.
5. Grasp the handle at the top of the upper filter body, turn counterclockwise until the Relief valve unit is aligned with the "UNLOCK" position on the upper filter body and make sure the unit is completely loosened and lift out.
6. Pull straight up to remove the relief valve and handle.

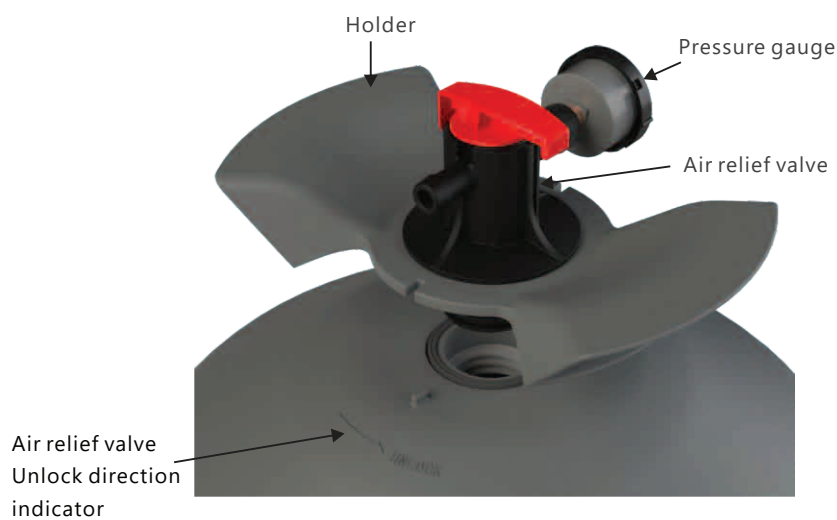

Figure 8

4.5.1 RE-INSTALLATION OF THE AIR RELIEF VALVE.

1. Check the condition of the O-ring, replace it as necessary
2. With a clean cloth, wipe the upper filter body and O-ring groove. Remove all dirt and debris.
3. Making sure the stopper of the flange is in the open position.
4. Verify the Air relief valve discharge points away from all electrical connections.

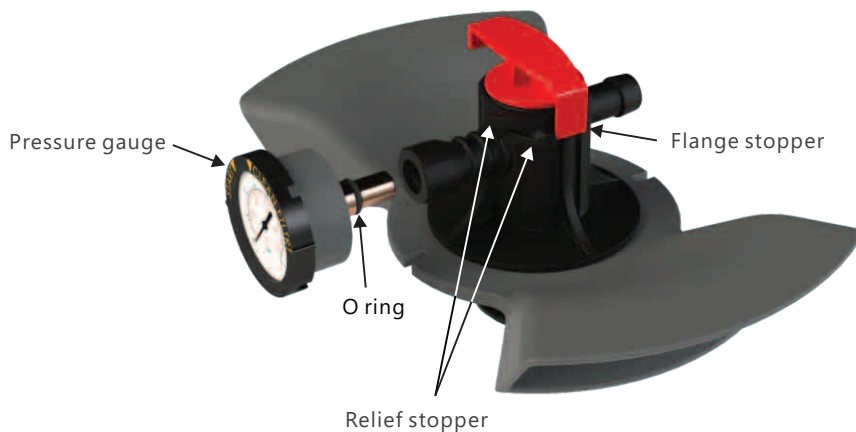

Figure 9

5. WINTERIZING FILTER

In areas where sub-freezing temperatures can be expected, the filter should be drained to protect the filter from damage.

1. Follow the steps in "Filter disassemble instruction" to remove and clean the cartridge.
2. Reinstall the cartridge in the filter.
3. Fully tighten the lock ring while storing.
4. Reassemble per FILTER REASSEMBLY INSTRUCTIONS.
5. Be sure to leave the drain plug unattached during the winter season to avoid cracking the filter body.

6. TROUBLE SHOOTING

	Low water Flow	SHORT FILTER CYCLES	POOL WATER REMAINS CLOUDY
REMEDY	<ol style="list-style-type: none"> 1. Check skimmer and pump strainer baskets for debris. 2. Check for restrictions in intake and discharge lines. 3. Check for air leak in intake line indicated by bubbles returning to pool. 4. Clean Filter Cartridges 	<ol style="list-style-type: none"> 1. Check for algae in the pool and super-chlorinate as required. 2. Be sure chlorine and pH levels are in a proper range (adjust as required). 	<ol style="list-style-type: none"> 1. Check chlorine, pH, and total alkalinity levels and adjust as required. 2. Be sure the flow rate through the filter is sufficient. 3. Operate filter for longer periods.

6.1 WATER CHEMISTRY

SUGGESTED POOL CHEMISTRY LEVELS	
pH LEVEL	7.2 to 7.8
TOTAL ALKALINITY	80 to 120 ppm
CALCIUM HARDNESS	200 to 400 ppm
COMBINED CHLORINE	0.2 ppm Maximum
CHLORINE (STABILIZED)	1.0 to 3.0 ppm
CHLORINE STABILIZER (Cyanuric Acid)	60 to 80 ppm

7. SPARE PART LIST

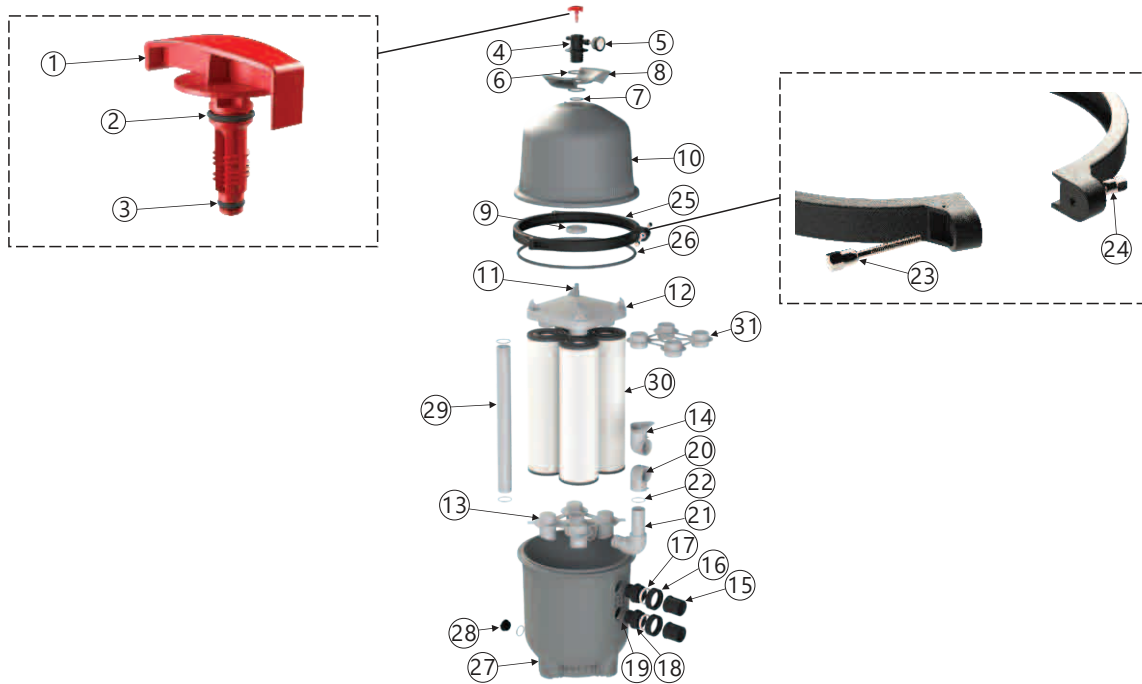

Key No.	Part No.	Description	QTY
1	550178232	Handle Air relief valve	1
2	111040077	O-ring d14.3×2.5	1
3	111040078	O-ring d6×3.5	1
4	550178233	Air relief valve	1
5	117038519	Pressure gauge 60psi , plastic casing	1
6	111040079	O-ring d50×5	1
7	111000048	O-ring D76 x d65.6 x 5	2
8	430138225	Handle for the lid	1
9	550058225	Nut for Handle	1
10			1
			1
	550188174	Lid for ICF430	1
			1
11	4109000749	Air release vent	1
12	E140402	Top Manifold plate	1
13	550008229	Bottom seal plate	1
14	550128230	Inlet adaptor	1
15	430308158	Union 2inch/2.5inch ANSI	2
16	430178159	Union Nut 2" 90	2
17	111040071	O-ring D77Xd62X8	2
18	430248177	Outer thread connector	2
19	111040081	O-ring d63.8×5	2
20	550128231	Outlet adaptor	1
21	E140403	Elbow assemble	1

Key No.	Part No.	Description	QTY
22	111040080	O-ring d50.5×2.5	4
23	112000083	Screw 3/8in	1
24	112030022	Nut 3/8in	1
25	E140404	Clamp unit	1
26	111000043	Sealing O ring D526×d502x14	1
27	550228177	Bottom Body	1
28	E160553	Drain Plug with O-ring	1
29			1
			1
	107048529	PVC Pipe 658mm for ICF430	1
			1
			1
30			4
			4
	914100009	Cartridge Element ICF430	4
			4
			8
31			1

8. TERMS OF THE WARRANTY

As original purchaser of this equipment have purchased from Reltech Australia Pty Ltd, through Authorized International Distributor or Dealer, warrants its products free from defects in materials and workmanship under normal use during warranty period. The warranty period begins on the day of purchase and extends only to the original purchaser. It is not transferable to anyone who subsequently purchases the product from you. It excludes all expendable parts.

During the warranty period, Reltech authorized reseller will repair or replace defective parts with new parts or, at the option of Reltech, serviceable used parts that are equivalent or superior to new parts in performance.

This Limited Warranty extends only to products purchased from Emaux authorized reseller. Does not extend to any product that has been damaged or rendered defective.

- (a) as a result of accident, misuse or abuse;
- (b) as a result of natural disaster;
- (c) by operation outside the usage parameters stated herein;
- (d) by the use of parts not manufactured or sold by Reltech;
- (e) by modification of the product;
- (f) as a result of war or terrorist attack; or
- (g) as a result of service by anyone other than Reltech authorized reseller or authorized agent.

EXCEPT AS EXPRESSLY NO OTHER WARRANTIES EXPRESSED OR IMPLIED, INCLUDING ANY IMPLIED WARRANTIES OR MERCHANTABILITY AND FITNESS FOR A PARTICULAR PURPOSE. RELTECH EXPRESSLY DISCLAIMS ALL WARRANTIES NOT STATED IN THIS LIMITED WARRANTY. ANY IMPLIED WARRANTIES THAT MAY BE IMPOSED BY LAW ARE LIMITED TO THE TERMS OF THIS EXPRESS LIMITED WARRANTY.



RELTECH

POOL EQUIPMENT

RELTECH AUSTRALIA PTY LTD
43-45 KYLTA RD,
WEST HEIDELBERG VIC 3081

PH: 03 94593838
EM: office@reltech.com.au
WEB: www.reltech.com.au

www.reltech.com.au