



SINGLE ELEMENT CARTRIDGE FILTER

Installation and Operation



USER MANUAL

Models: GX200

TABLE OF CONTENT

PAGE	2 IMPORTANT SAFETY INSTRUCTIONS
	3 1. OVERVIEW
		1.1 PRODUCT INFORMATION
		1.2 DIMENSIONS
	4 2. INSTALLATION
	5 3. STARTING THE PUMP AND FILTER SYSTEM
		3.1 BEFORE STARTING THE PUMP
		3.2 STARTING PUMP
		3.3 OPERATION
	6 4. MAINTAINING YOUR FILTER
		4.1 FILTER DISASSEMBLY INSTRUCTION
		4.2 REMOVING CARTRIDGE
		4.3 CLEANING CARTRIDGE
		4.4 FILTER REASSEMBLY INSTRUCTION
		4.4.1 RE-INSTALLING CARTRIDGE
		4.4.2 CLEAN SEAL RING AND SEAL SURFACE
		4.4.3 BODY AND LOCK RING RE-ASSEMBLY
		4.4.4 VACUUMING POOL
		4.5 REMOVING THE AIR RELIEF VALVE
		4.5.1 RE-INSTALLATION OF THE AIR RELIEF VALVE
	8 5. WINTERIZING FILTER
	8 6. TROUBLE SHOOTING
		6.1 WATER CHEMISTRY
	9 7. SPARE PART LIST
	10 8. TERMS OF THE WARRANTY

IMPORTANT SAFETY INSTRUCTIONS



THESE OPERATING INSTRUCTIONS CONTAIN IMPORTANT INFORMATION ON THE SAFE, PROPER, AND ECONOMICAL OPERATION OF THIS SWIMMING POOL APPLIANCE. STRICT OBSERVATION OF THE OPERATING INSTRUCTIONS WILL HELP TO AVOID DANGERS, REDUCE REPAIR COSTS, AND SHUTDOWN TIMES AND INCREASE THE RELIABILITY AND WORKING LIFE OF THE PRODUCT.

Failure to follow the instructions in this manual may result in serious adverse health effects or even serious or fatal injury. Failure to follow the instructions in this manual will in all cases invalidate all guarantees and liability on the part of the manufacturer.

Consumer Information and Safety

These Cartridge Filters are designed and manufactured to provide years of safe and reliable operation. Operated and maintained according to the information in this manual and the installation codes referred to in later sections.

THIS FILTER OPERATES UNDER HIGH PRESSURE

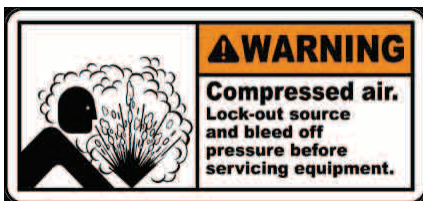

When any part of the circulating system, (e.g., closure, pump, filter, valve(s), etc.), is serviced, air can enter the system and become pressurized. Pressurized air can cause the top closure to separate which can result in severe injury, death, or property damage. To avoid this potential hazard, follow these instructions:

1. If you are not familiar with your pool filtering system:
 - (1) Do NOT attempt to adjust or service without consulting your dealer, or a qualified pool technician.
 - (2) Read the entire Installation & Operation Manual before attempting to use, service, or adjust the pool filtering system.
2. Before repositioning valve(s) and before beginning the assembly, disassembly, or any other service of the circulating system:
 - (1) Turn the pump OFF and shut OFF any automatic controls to ensure the system is NOT inadvertently started during the servicing;
 - (2) Open the air relief valve;
 - (3) Wait until all pressure is relieved.
3. Whenever installing the filter closure follow the filter closure warnings exactly.
4. Once service on the circulating system is complete follow initial start-up instructions exactly.
5. Maintain circulation system properly. Replace worn or damaged parts immediately, (e.g., closure, pressure gauge, valve(s), O-rings, etc.).
6. Be sure that the filter is properly mounted and positioned according to the instructions provided.



This filter must be installed by licensed or certified electrician or qualified pool serviceman in accordance with the Local Code and all applicable local codes and ordinances.

Improper installation could result in death or serious injury to pool users, installers, or others and may also cause damage to property.

Always disconnect power to the pool circulating system at the circuit breaker before servicing the filter. Ensure that the disconnected circuit is locked out or properly tagged so that it cannot be switched on while you are working on the filter. Failure to do so could result in serious injury or death to a serviceman, pool user, or others due to electric shock.

READ UNDERSTAND AND FOLLOW ALL SAFETY AND OPERATION:



Do not operate the filter until you have read and understand clearly all the operating instructions and warning messages for all equipment that is a part of the pool circulating system. The following instructions are intended as a guide for initially operating the filter in a general pool installation. Failure to follow all operating instructions and warning messages can result in property damage or severe personal injury or death.



To reduce the risk of injury, do not permit children to use this product.



ELECTROCUTION HAZARD

Direct water discharge from air relief valve away from electrical service. Do not locate pump control over near the filter.

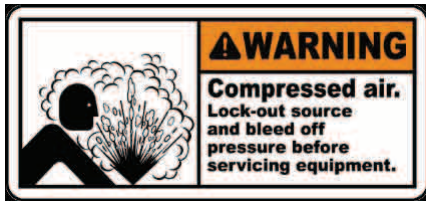

Due to the potential risk that can be involved, it is recommended that the pressure test be kept to the minimum time required by the local code. Do not allow people to work around the system when the circulation system is under the pressure test. Post appropriate warning signs and establish a barrier around the pressurized equipment. If the equipment is located in an equipment room, lock the door and post a warning sign.

Never attempt to adjust any closures or lids or attempt to remove or tighten bolts when the system is pressurized. These actions can cause the closure to separate and could cause severe personal injury or death if they were to strike a person.

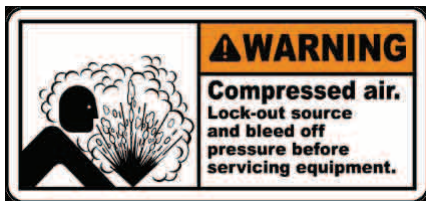

Never exceed the maximum operating pressure of system components. Exceeding these limits could result in a component failing under pressure. This instantaneous release of energy can cause the closure to separate and could cause severe personal injury or death if they were to strike a person.



HYPERTHERMIA

SPA water temperature excess of 38°C (104°F) may be injurious to health. Measure water temperature before entering SPA to strike a person.

Hyperthermia occurs when the internal temperature of the body reaches a level several degrees above the normal body temperature of 98.6 °F (37 °C). The symptoms of hyperthermia include drowsiness, lethargy, and an increase in the internal temperature of the body.

1. OVERVIEW

GX series cartridge filter combines superior water filtration with ease of operation and corrosion-free construction. With filtration ratings of 6,000~7,200 gallons (22,710 ~ 27,250 liters) per hour, they are designed for continuous or intermittent operation, for installation above or below the pool waterline, for fresh or saltwater swimming pools or spas. GX series filters utilize multiple reusable, reinforced polyester filter cartridge elements to provide a high degree of water clarity and long filter cycles with minimum care.

1.1 PRODUCT INFORMATION

Model	EFFECTIVE FITRATION AREA		DESIGN FLOW RATE	
	FT ²	M ²	Residential GPM	Commercial LPM
GX200	200	18.58	120	455

[Filter rate for residential use based on 1GPM/ft². Recommend Flow Rate for 2" piping is $90 \leq x \leq 150$ GPM]

1.2 DIMENSIONS

Model	A		B		C		D	
	IN	CM	IN	CM	IN	CM	IN	CM
GX200	20.9	53.05	17.24	43.80	18.30	46.40	3.20	8.20

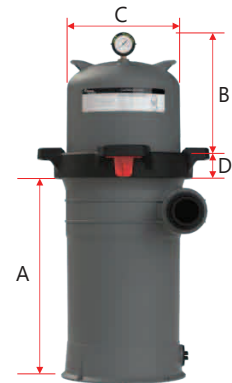

2. INSTALLATION

This product should be installed and serviced only by qualified pool professional.

1. The filter system should be installed on a level concrete slab or another rigid base. Select a well-drained and vented area, that does not flood when it rains. Position the filter so that the piping connections and winter drain are convenient and accessible for operation, service, maintenance, and winterizing.
2. Position filter body such that all operation and safety labels are visible.
3. Position the filter so the filter will drain by gravity.
4. If practical, place the pump and filter in the shade to shield it from direct sunlight.
5. Connect the pool suction plumbing between the skimmer, the pool outlet (from the pool), and the pump.
6. Install the plumbing from the filter to the pool (return to the pool)
7. Do not locate pump controls over or near the filter.
8. Verify water discharge from the manual air Relief valve is directed away from electrical devices.

MODEL	A		REQUIRED CLEARANCE			
			"B" side		"C" above	
	IN	CM	IN	CM	IN	CM
GX200	40.7	103.4	18.3	46.4	11.8	30

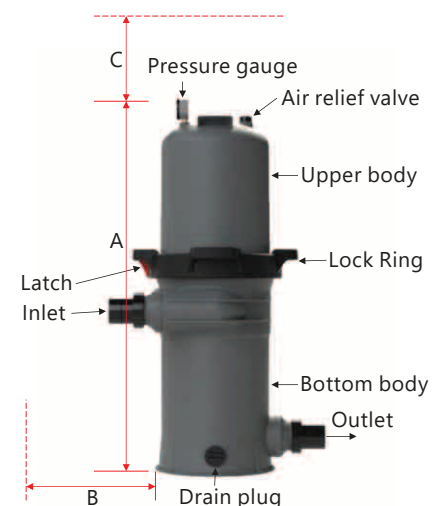

3. STARTING THE PUMP AND FILTER SYSTEM

3.1 BEFORE STARTING THE PUMP

1. Use ONLY GX system components: Lock Ring unit doing assembly, metal-reinforced seal. Non-tighten lock ring component may fail in use and cause explosive component separation. Verify that upper and lower filter bodies are properly secured with the filter body locking ring unit. Make sure tightening enough the Lock Ring to the filter's upper and bottom body. Verify that the filter manual air relief valve is in the LOCK position, and no filter components are missing, damaged, or not genuine GX filter components.

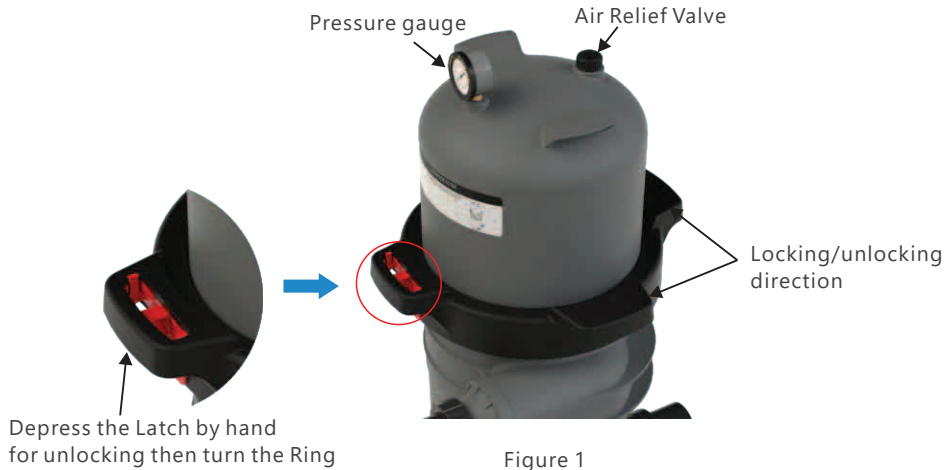

2. Close filter drain. Note: Drain plug requires an O ring seal.

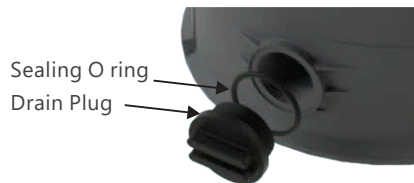

3. Open all system valves to allow water from the pool to the filtration system and from the filter to return to the pool.
4. Place the air relief valve in an OPEN position.



3.2 STARTING PUMP

Stand clear of pump during start-up

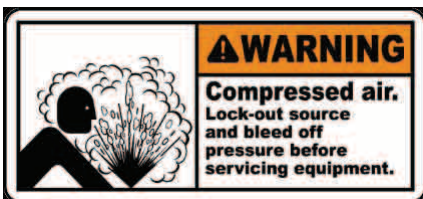

Pool and spa circulation systems operate under high pressure. When any part of the circulating system (i.e. lock ring, pump, filter, valves, etc.) is serviced, air can enter the system and become pressurized. Filter tank Lid and pre-filter cover must be secured to prevent violent separation. Place the pre-filter / filter air relief valve in an open position and wait for all pressure in the system to be relieved before removing the lid from access to the basket for cleaning.

When starting the system pump, do not stand over or near the filter. If water leakage appears at the lock ring. Turn off all system circulation pumps and all electrical power immediately. Do not return to the filter until all water leakage has stopped.

Only return to filter to close air relief valve when water came out.

3.3 OPERATION

Filtration starts as soon as the flow is steady through the filter. As the filter removes dirt from the pool water, the accumulated dirt causes a resistance to flow. As a result, the pressure will rise and the flow will decrease.

1. Record the initial starting pressure which is the initial pressure reading when a new filter element is working under filtration conditions.
2. Every time after reinstalling “new filter element” or “after cleaned filter cartridge element”, make sure the system is under filtration condition, then turn the START arrow to the pressure gauge pointer position to indicate the Start pressure.
3. Monitor the pressure from time to time, when the pressure reading is over the Clean Filter arrow, follow step 4.2 to clean filter cartridge elements.



Figure 4

Replace a new filter cartridge element.

You should replace a new filter cartridge element:

1. After cleaning the filter element, if the pressure is:
 - a. 25 psi higher than the initial start ready, or
 - b. the pressure reading is over 40 psi.
2. When the filter element is broken, or the layer peers off.
3. When the pressure or flow rate is below the desired rate of the system.

4. MAINTAINING YOUR FILTER

4.1 FILTER DISASSEMBLY INSTRUCTION

1. Turn off all system circulation pumps and all electrical power on the equipment pad.
2. Set all system valves in a position to prevent water from flowing to the filter.
3. Turn the air relief valve OPEN.
4. Remove the filter drain plug, and water flows out from the filter.
5. Depress the latch and unscrew the lock ring (counterclockwise).
6. Liff off filter upper body with the attached lock ring. Do not hold the pressure gauge to lift the upper body.
7. Lift out the cartridge element.

4.2 REMOVING CARTRIDGE

1. Remove the filter cartridge element by using a slight rocking motion and lifting.
2. Clean filter cartridge element.

4.3 CLEANING CARTRIDGE

The cartridge filter element can be washed inside and outside by a garden hose. After hosing the cartridge, for best results, carefully brush the pleated surface to remove fine particles. Do not use high-pressure water to wash as it can damage the filter element.

You may find some debris on the cartridge pleats, which may not have been removed with hosing.

4.4 FILTER REASSEMBLY INSTRUCTION

4.4.1 RE-INSTALLING CARTRIDGE

1. Flush and drain any dirt or debris from the bottom of the lower filter body.
2. Flush any dirt or debris from the upper filter body and from around the air release area.

3. Carefully replace the cartridge over the hubs on the bottom manifold.
4. Place the upper body securely on top of the cartridge.

4.4.2 CLEAN SEAL RING AND SEAL SURFACE

1. Remove filter tank sealing O-ring.
2. With a clean cloth, wipe the lower filter body seal surface and clean seal of all dirt and debris. Do not use any solvent.
3. With a clean cloth wipe the upper body seal surface.



Figure 5

4.4.3 BODY AND LOCK RING RE-ASSEMBLY

1. Place the sealing O-ring on the bottom body. Place the upper body on the O-ring and the bottom body.
2. Use the EMAUX lock ring system only, tighten the lock ring (clockwise) until the latch is locked on position.
3. Ensure that upper and bottom bodies are properly secured with the lock ring.

NOTE: DO NOT HIT OR STRIKE THE CLAMP WITH A HAMMER OR METAL TOOLS.

4. Ensure that the air relief valve assembly is in an OPEN position and no components are damaged or missing.
5. Ensure the drain plug is closed.
6. Open all system valves to allow water from the pool to the filtration system and from the filter to the pool.
7. Wait for the water to come out from the air relief valve then turn the air relief valve to fully CLOSE .

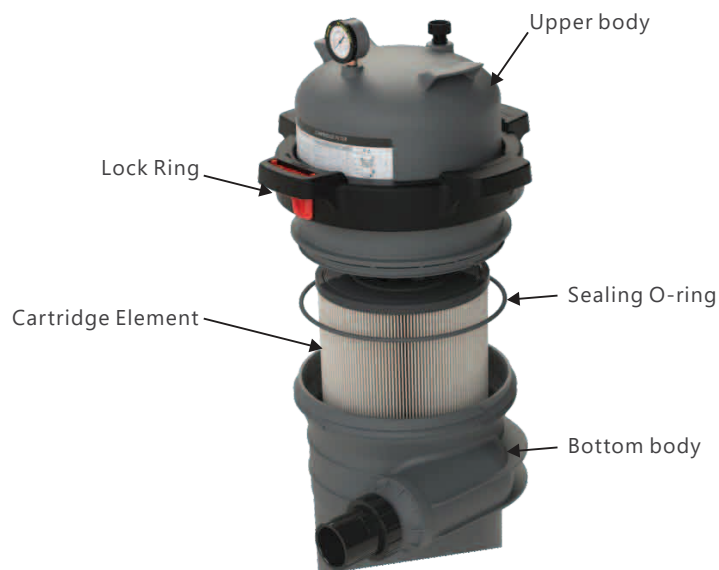

Figure 6

4.4.4 VACUUMING POOL

Vacuuming can be performed directly into the filter whenever needed. Clean cartridge after vacuuming if required.

4.5 REMOVING THE AIR RELIEF VALVE

The filter comes with a preinstalled manual air relief valve. Servicing the Air Relief Valve should be carried out by pool professionals only, follow instructions carefully:

1. Turn off all system circulation pumps and all-electric power on the equipment pad.
2. Set all system valves in a position to prevent water from flowing to the filter.
3. The air relief valve must be placed in the OPEN position.
4. Wait until all water leakage has stopped.
5. Grasp the Relief valve Nut at the release position, and turn the Nut counterclockwise until the Air gauge indicator is on the "0" position on the upper filter body.
6. Keep on turning the Nut of the release valve until it leaves the Upper filter body.

4.5.1 RE-INSTALLATION OF THE AIR RELIEF VALVE

1. Check the condition of the O-ring, replace it as necessary
2. With a clean cloth, wipe the upper filter body and O-ring groove. Remove all dirt and debris.
3. Twist the air relief valve with the tool until it's tightened on top of the upper filter body.
4. Make sure the nut of the Release valve is tight.
5. Verify the air relief valve discharge points away from all electrical connections.

5. WINTERIZING FILTER

In areas where sub-freezing temperatures can be expected, the filter should be drained to protect the filter from damage.

1. Follow the steps in "Filter disassemble instruction" to remove and clean the cartridge.
2. Reinstall the cartridge in the filter.
3. Fully tighten the lock ring while storing.
4. Reassemble per FILTER REASSEMBLY INSTRUCTION.
5. Be sure to leave the drain plug unattached during the winter season to avoid cracking the filter body.

6. TROUBLE SHOOTING

	Low water Flow	SHORT FILTER CYCLES	POOL WATER REMAINS CLOUDY
REMEDY	<ol style="list-style-type: none"> 1. Check skimmer and pump strainer baskets for debris. 2. Check for restrictions in intake and discharge lines. 3. Check for air leak in intake line indicated by bubbles returning to pool. 4. Clean Filter Cartridges 	<ol style="list-style-type: none"> 1. Check for algae in the pool and super-chlorinate as required. 2. Be sure chlorine and pH levels are in a proper range (adjust as required). 	<ol style="list-style-type: none"> 1. Check chlorine, pH, and total alkalinity levels and adjust as required. 2. Be sure the flow rate through the filter is sufficient. 3. Operate filter for longer periods.

6.1 WATER CHEMISTRY

SUGGESTED POOL CHEMISTRY LEVELS	
pH LEVEL	7.2 to 7.8
TOTAL ALKALINITY	80 to 120 ppm
CALCIUM HARDNESS	200 to 400 ppm
COMBINED CHLORINE	0.2 ppm Maximum
CHLORINE (STABILIZED)	1.0 to 3.0 ppm
CHLORINE STABILIZER (Cyanuric Acid)	60 to 80 ppm

7. SPARE PART LIST



Key No.	Part No.	Description	QTY
1	117068519	Pressure gauge 60psi, plastic casing	1
2			1
2			1
2	550188200	Upper Body ICF200	1
3	570818164	Nut D22X15	1
4	550058153	Lock Ring	1
5	550058196	Latch	1
6	11000036	O-ring D306Xd7.5	1
7	430178159	Union nut 2"	2
8	430308158	Union 2inch/2.5inch ANSI	2
9	111040071	O-ring D77Xd62X8	2
10	E140401	ICF100-200 Bottom Body	1
11	E160553	End cap with O-ring	1
12	E010201	Air Relief Valve with O-ring	1
13	570818165	Nut D31X20 14G	1
14			1
14			1
14	914100006	ICF200 Element	1
15			1
15			1
15	107048520	PVC Pipe 2.5inch for ICF200, 517mm	1
16	550128166	ICF100-200 Center Drain connection	1

8. TERMS OF THE WARRANTY

As original purchaser of this equipment have purchased from Reltech Australia Pty Ltd, through Authorized International Distributor or Dealer, warrants its products free from defects in materials and workmanship under normal use during warranty period. The warranty period begins on the day of purchase and extends only to the original purchaser. It is not transferable to anyone who subsequently purchases the product from you. It excludes all expendable parts.

During the warranty period, Reltech authorized reseller will repair or replace defective parts with new parts or, at the option of Reltech, serviceable used parts that are equivalent or superior to new parts in performance.

This Limited Warranty extends only to products purchased from Reltech authorized reseller. Does not extend to any product that has been damaged or rendered defective.

- (a) as a result of accident, misuse or abuse;
- (b) as a result of natural disaster;
- (c) by operation outside the usage parameters stated herein;
- (d) by the use of parts not manufactured or sold by Reltech
- (e) by modification of the product;
- (f) as a result of war or terrorist attack; or
- (g) as a result of service by anyone other than Reltech authorized reseller or authorized agent.

EXCEPT AS EXPRESSLY NO OTHER WARRANTIES EXPRESSED OR IMPLIED, INCLUDING ANY IMPLIED WARRANTIES OR MERCHANTABILITY AND FITNESS FOR A PARTICULAR PURPOSE. RELTECH EXPRESSLY DISCLAIMS ALL WARRANTIES NOT STATED IN THIS LIMITED WARRANTY. ANY IMPLIED WARRANTIES THAT MAY BE IMPOSED BY LAW ARE LIMITED TO THE TERMS OF THIS EXPRESS LIMITED WARRANTY.



RELTECH

POOL EQUIPMENT

RELTECH AUSTRALIA PTY LTD
43-45 KYLTA RD,
WEST HEIDELBERG VIC 3081

PH: 03 94593838
EM: office@reltech.com.au
WEB: www.reltech.com.au

www.reltech.com.au